

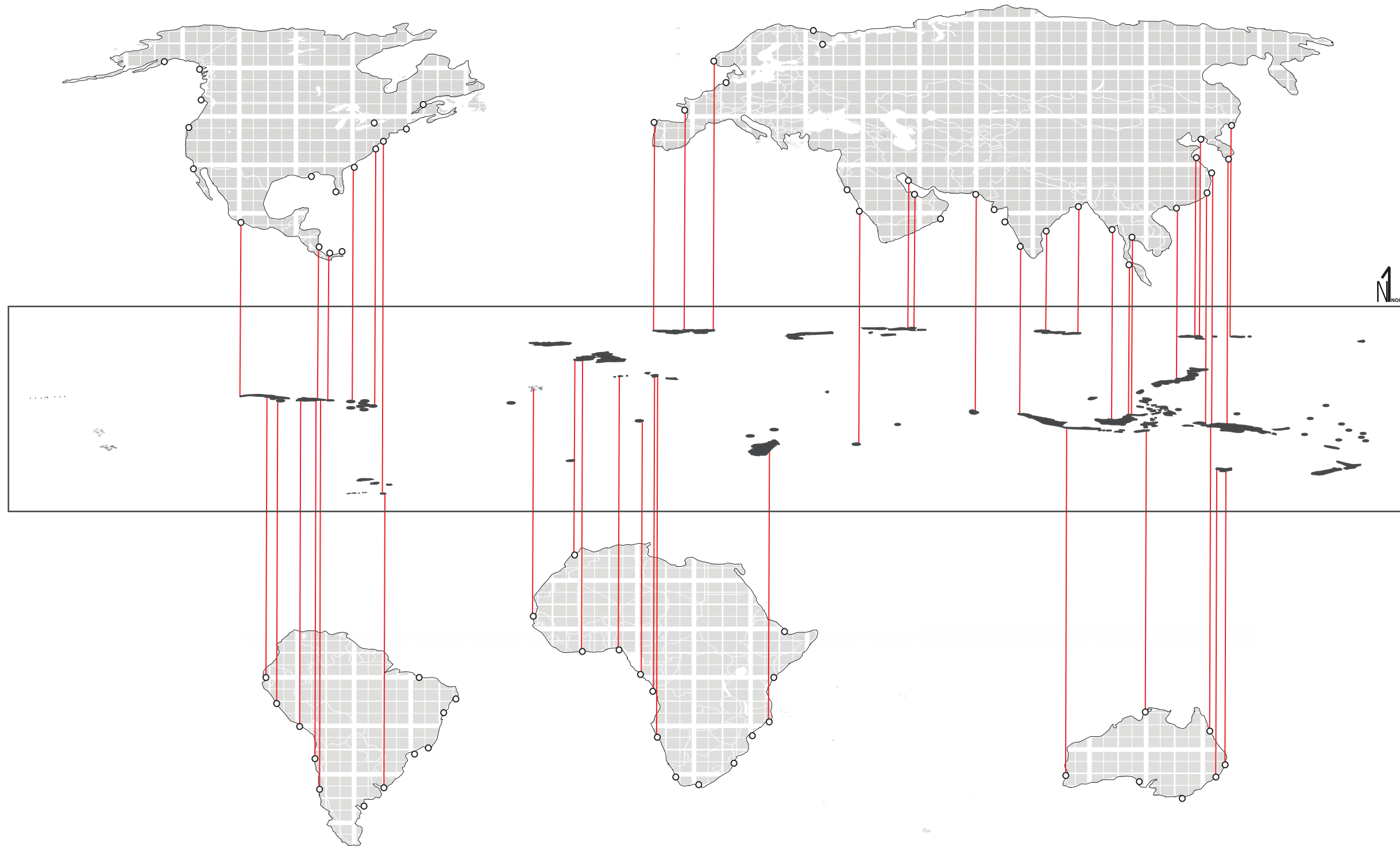



ECOBALANCE OPEN SOURCE PLANNING



-  MAJOR HARBOR
-  CONTINENTAL LAND MASS
-  ISLAND NATIONS
-  PROXIMITY TO MAJOR HARBORS

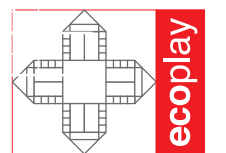

ecoplay

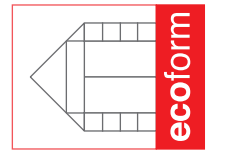

ecoform

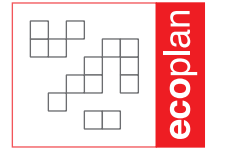

ecoplan



Island Nation Initiative

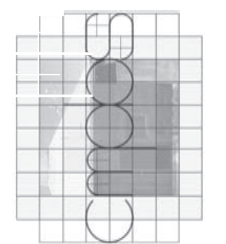

ISLAND NATION INITIATIVE

Island Locations

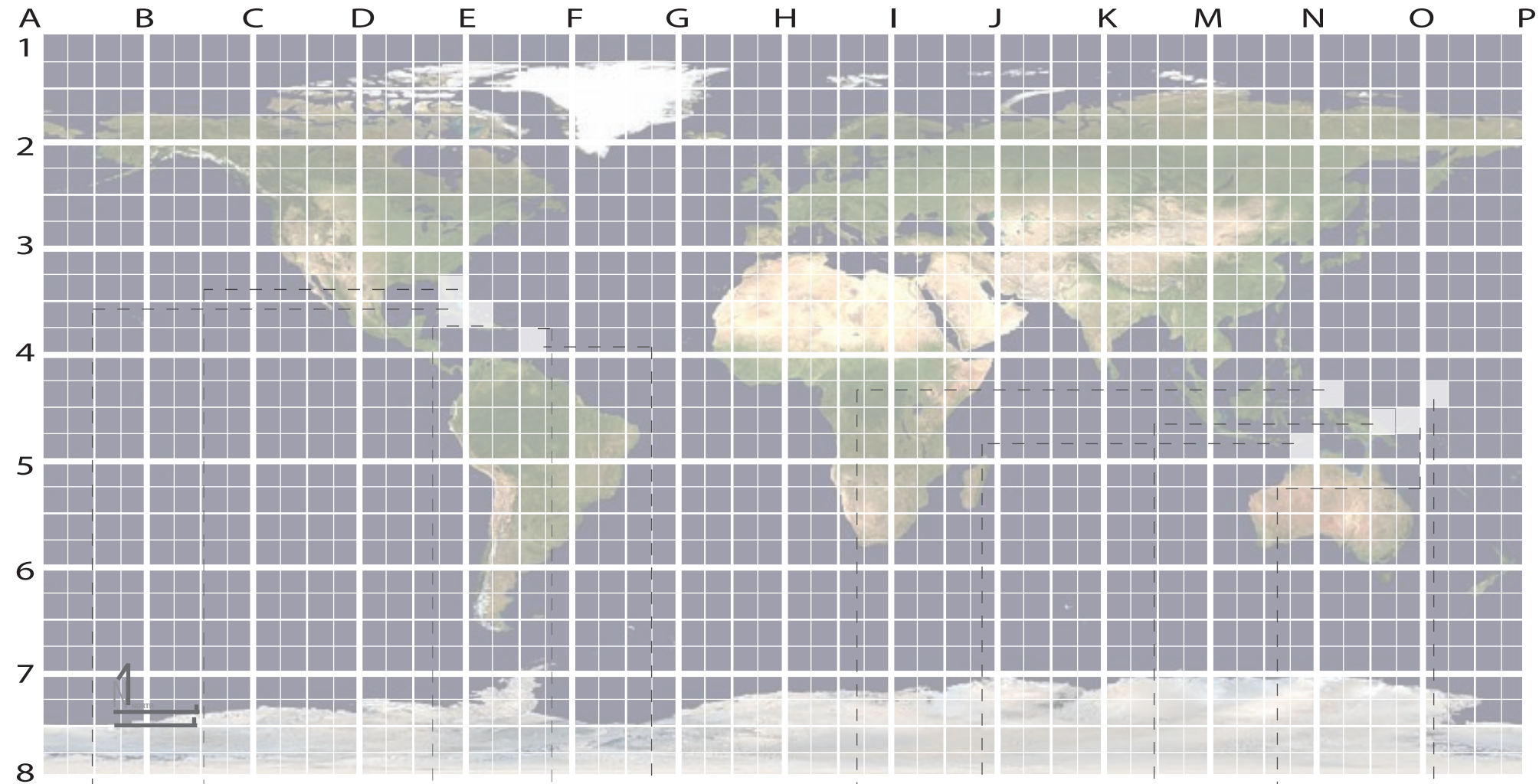

D.4,3.3
CUBA

E.1,3.2
THE BAHAMAS

E.1,3.3
HAITI

E.3,3.4
ANTIGUA +
BARBUDA

E.3,3.4
BARBADOS

N.1,4.2
PALAU

M.4,4.4
TIMOR LESTE

N.3,4.3
PAPUA NEW
GUINEA

N.4,4.3
SOLOMON ISLANDS

O.1,4.2
NAURU

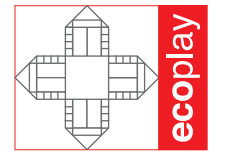
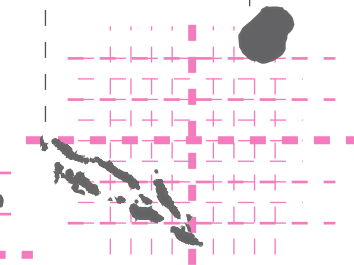
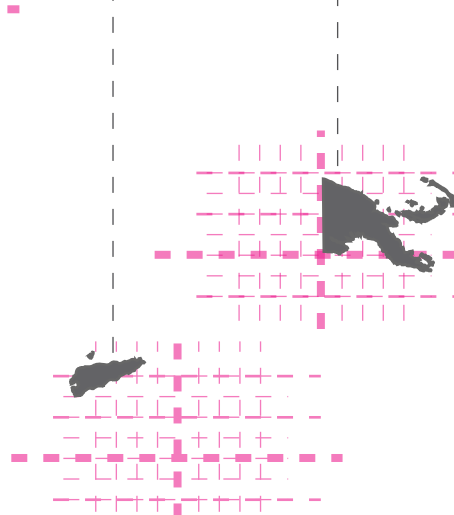
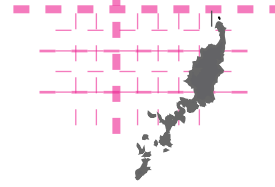
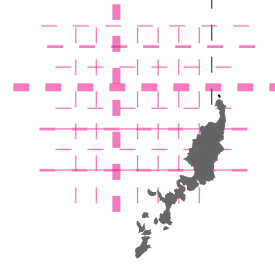
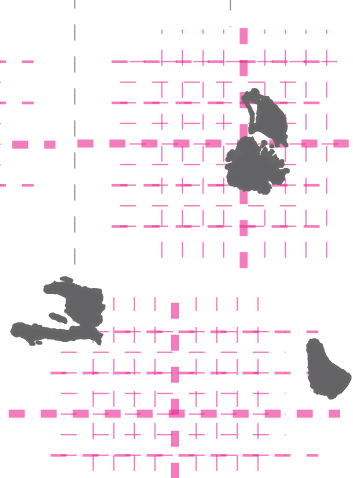
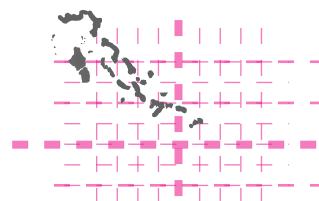
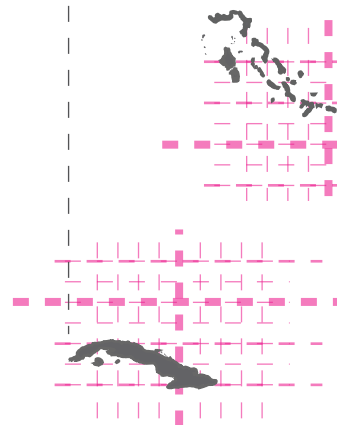

ecoplay



ecoform

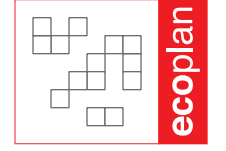

ecoplan

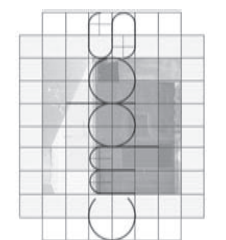

ISLAND NATION INITIATIVE

Sea Surface Temperature + Active Systems

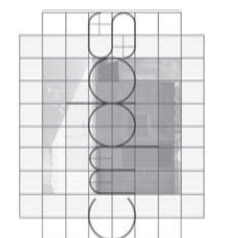
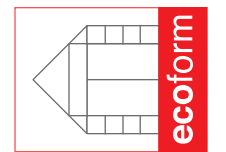
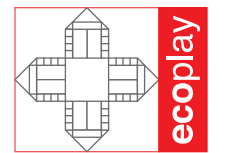
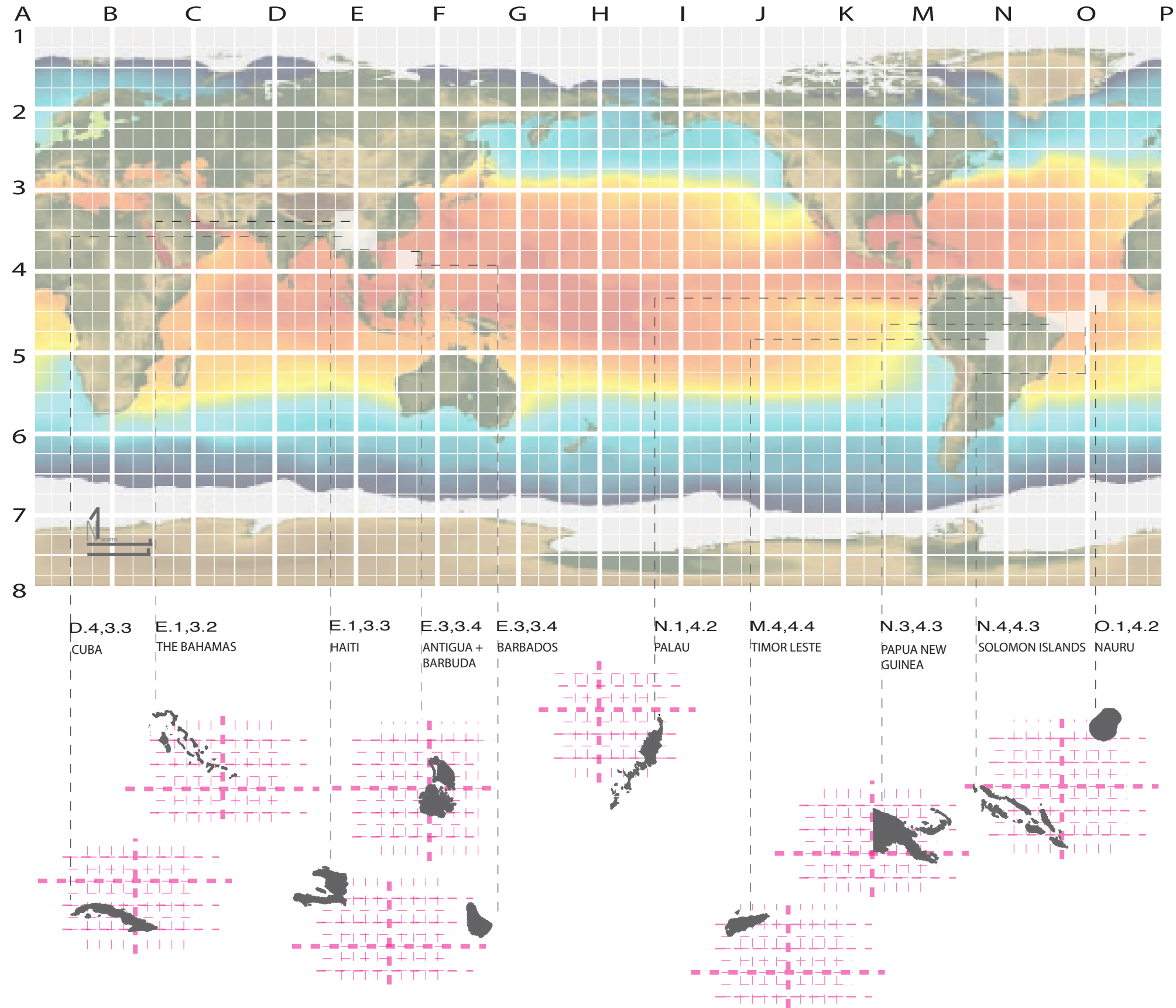

ISLAND NATION INITIATIVE

Island Risk

Tracks of nearly 150 years of tropical cyclones weave across the globe in this map. The map is based on all storm tracks available from the National Hurricane Center and the Joint Typhoon Warning Center through September 2006. The accumulation of tracks reveals several details of hurricane climatology, such as where the most severe storms form and the large-scale atmospheric patterns that influence the track of hurricanes.

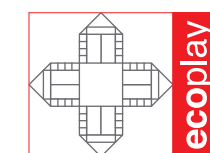
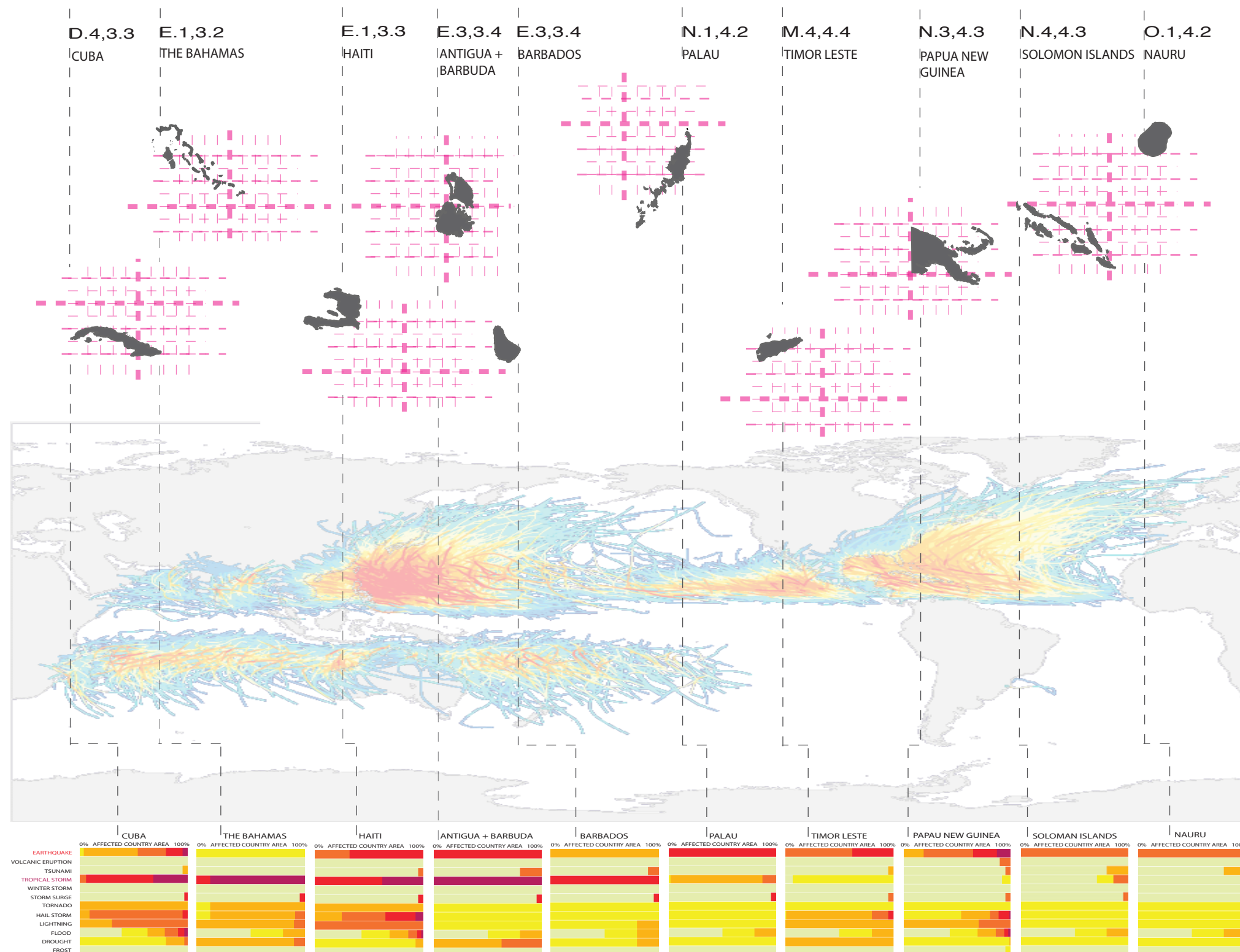

ecoplay

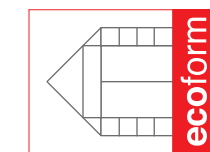

ecoform

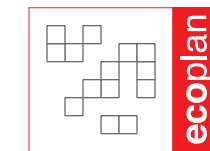

ecoplan



Island Nation Initiative

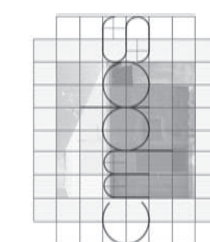

SUITABILITY ANALYSIS

Haiti Topography

The mainland of Haiti has three regions: the northern region, which includes the northern peninsula; the central region; and the southern region, which includes the southern peninsula. In addition, Haiti controls several nearby islands.

The northern region consists of the Massif du Nord (Northern Massif) and the Plaine du Nord (Northern Plain). The Massif du Nord, an extension of the central mountain range in the Dominican Republic, begins at Haiti's eastern border, north of the Guayamouc River, and extends to the northwest through the northern peninsula. The Massif du Nord ranges in elevation from 600 to 1,100 meters. The Plaine du Nord lies along the northern border with the Dominican Republic, between the Massif du Nord and the North Atlantic Ocean. This lowland area of 2,000 square kilometers is about 150 kilometers long and 30 kilometers wide.

The central region consists of two plains and two sets of mountain ranges. The Plateau Central (Central Plateau) extends along both sides of the Guayamouc River, south of the Massif du Nord. It runs eighty-five kilometers from southeast to northwest and is thirty kilometers wide. To the southwest of the Plateau Central are the Montagnes Noires, with elevations of up to approximately 600 meters. The most northwestern part of this mountain range merges with the Massif du Nord. Southwest of the Montagnes Noires and oriented around the Artibonite River is the Plaine de l'Artibonite, measuring about 800 square kilometers. South of this plain lie the Chaîne des Matheux and the Montagnes du Trou d'Eau, which are an extension of the Sierra de Neiba range of the Dominican Republic.

The southern region consists of the Plaine du Cul-de-Sac and the mountainous southern peninsula. The Plaine du Cul-de-Sac is a natural depression, twelve kilometers wide, that extends thirtytwo kilometers from the border with the Dominican Republic to the coast of the Baie de Port-au-Prince. The mountains of the southern peninsula, an extension of the southern mountain chain of the Dominican Republic (the Sierra de Baoruco), extend from the Massif de la Selle in the east to the Massif de la Hotte in the west. The range's highest peak, the Morne de la Selle, is the highest point in Haiti, rising to an altitude of 2,715 meters. The Massif de la Hotte varies in elevation from 1,270 to 2,255 meters.

- topography

- urban area
- population density
- populatin displacement
- road infrastructure
- harbor locations
- waterways
- slope
- soil
- earthquake
- landslide
- wave height
- surge height
- storm
- rainfall
- humidity
- wind speed
- flood
- drought / degredation

MAP OVERLAY INDEX

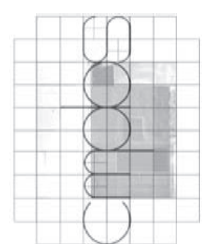
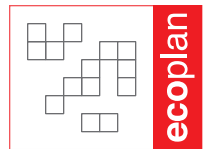
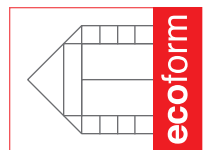
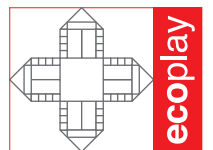
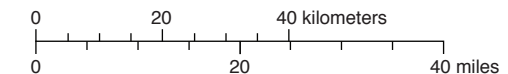
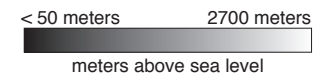
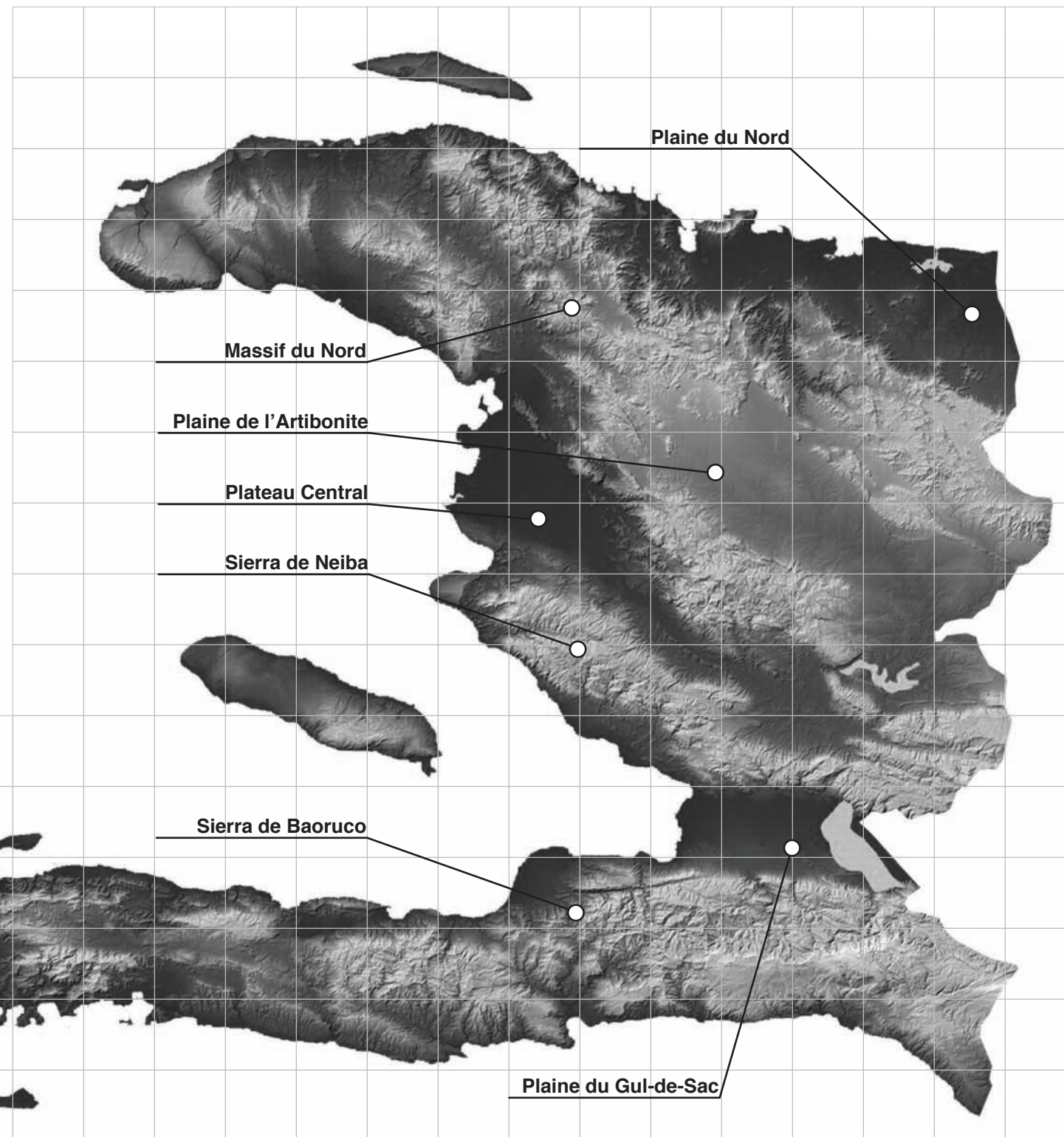

SUITABILITY ANALYSIS

Haiti Urban Area

Principal City	Population
Port-au-Prince	875,978
Carrefour	430,250
Delmas	359,451
Petionville	271,175
Citie Soleil	241,055
Gonaives	228,725
Cap-Haitien	155,505
Les Cayes	71,236
Hinche	30,595
Jacmel	39,643
Jeremie	34,788
Hinche	30,595
Fort Liberte	20,463
Miragoane	10,947

Metropolitan City	Population
Port-au-Prince	2,296,386
Cap-Haitien	244,660
Gonaives	228,725

- topography
- **urban area**
- population density
- populatin displacement
- road infrastructure
- harbor locations
- waterways
- slope
- soil
- earthquake
- landslide
- wave height
- surge height
- storm
- rainfall
- humidity
- wind speed
- flood
- drought / degredation

MAP OVERLAY INDEX

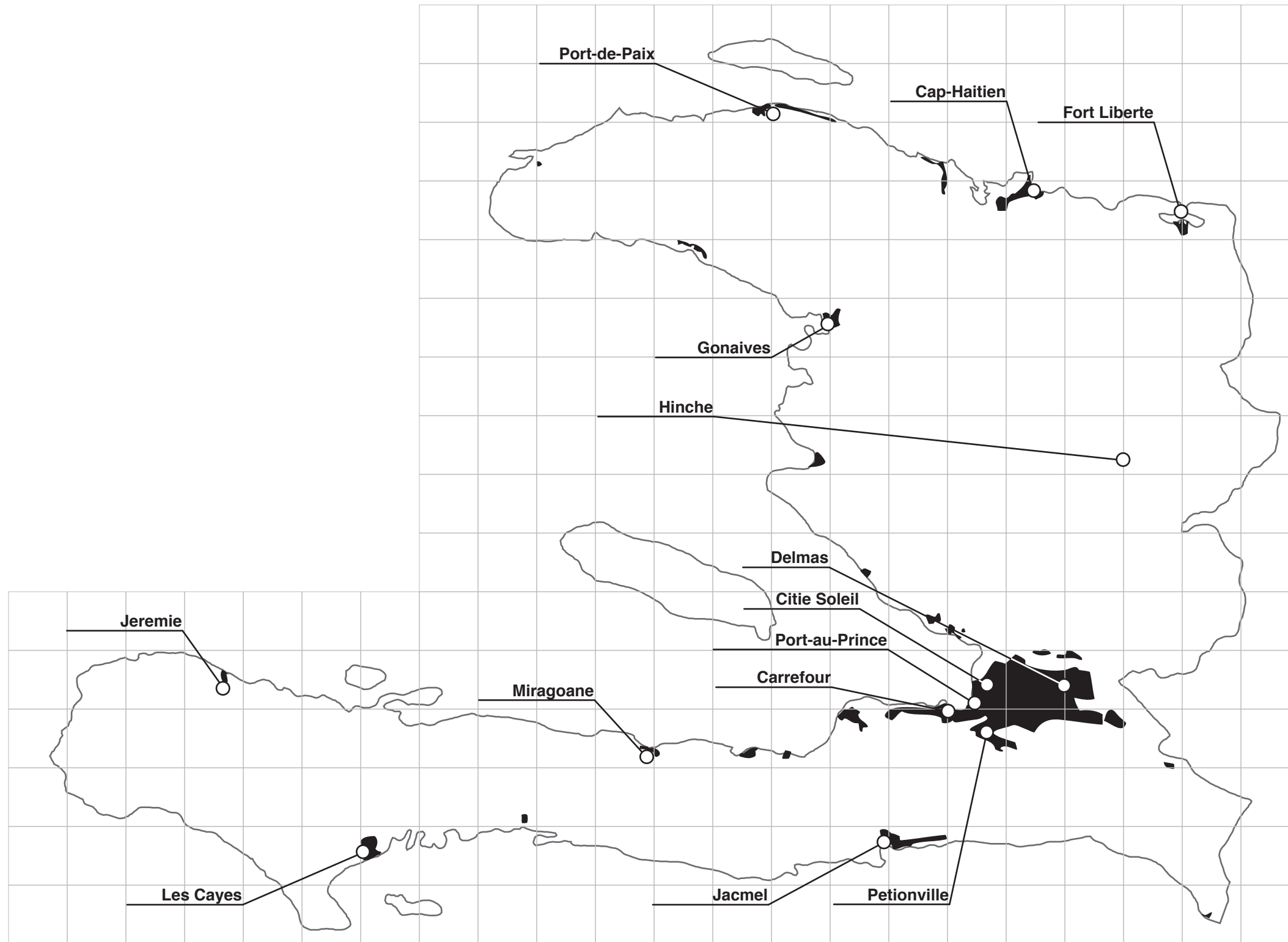

urban area

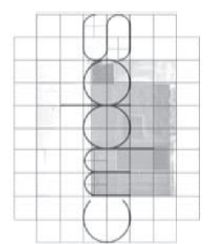
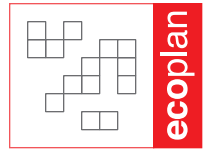
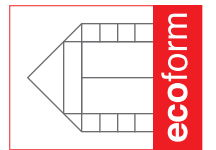
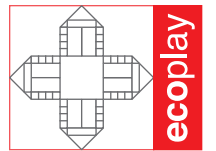
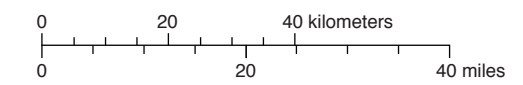

SUITABILITY ANALYSIS

Haiti Population Density

- topography
- urban area
- **population density**
- populatin displacement
- road infrastructure
- harbor locations
- waterways
- slope
- soil
- earthquake
- landslide
- wave height
- surge height
- storm
- rainfall
- humidity
- wind speed
- flood
- drought / degredation

MAP OVERLAY INDEX

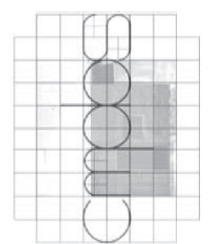
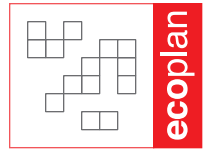
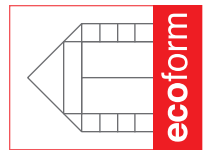
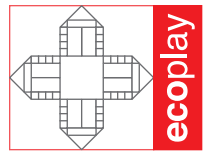
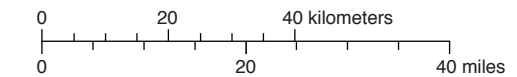
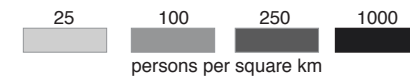

SUITABILITY ANALYSIS

Haiti Population Displacement

- topography
- urban area
- population density
- **population displacement**
- road infrastructure
- harbor locations
- waterways
- slope
- soil
- earthquake
- landslide
- wave height
- surge height
- storm
- rainfall
- humidity
- wind speed
- flood
- drought / degradation

MAP OVERLAY INDEX

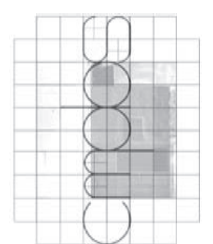
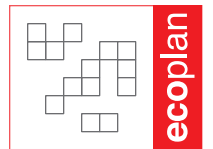
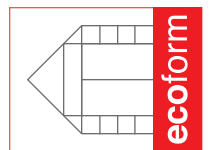
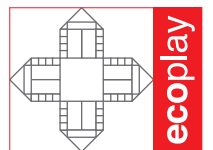
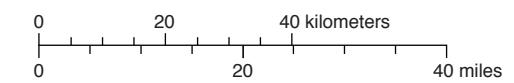
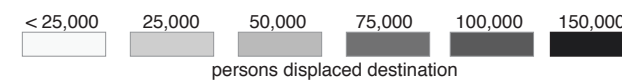

SUITABILITY ANALYSIS

Haiti Road Infrastructure

- topography
- urban area
- population density
- populatin displacement
- **road infrastructure**
- harbor locations
- waterways
- slope
- soil
- earthquake
- landslide
- wave height
- surge height
- storm
- rainfall
- humidity
- wind speed
- flood
- drought / degredation

MAP OVERLAY INDEX

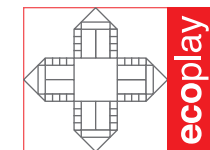
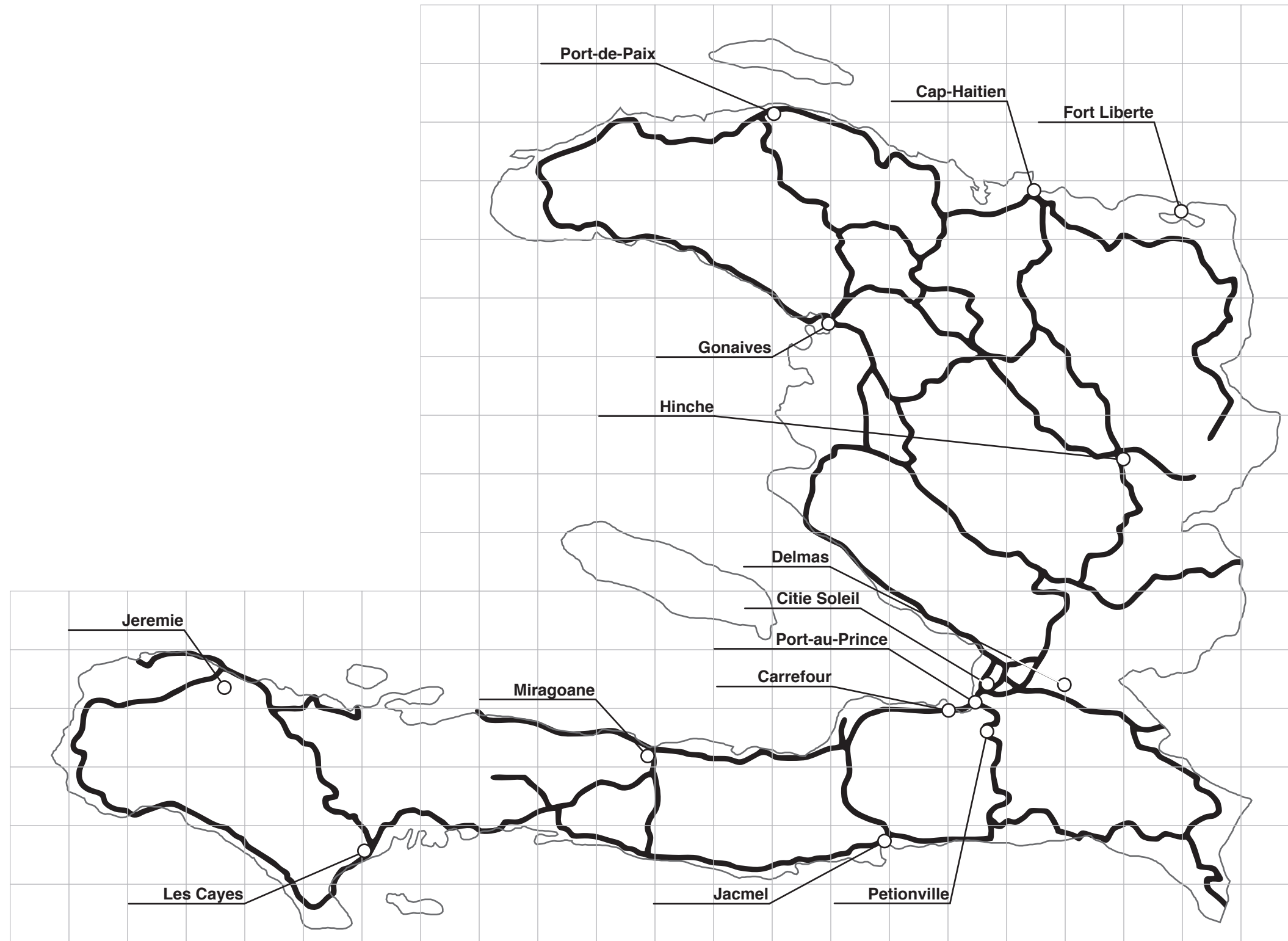

ecoplay

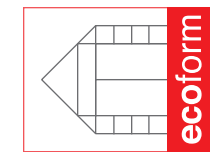

ecoform

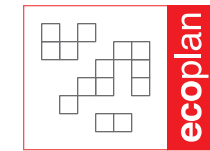

ecoplan



Island Nation Initiative

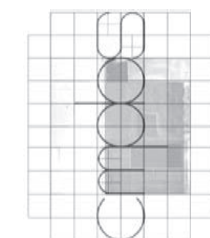

SUITABILITY ANALYSIS

Haiti Harbor Locations

- topography
- urban area
- population density
- populatin displacement
- road infrastructure
- **harbor locations**
- waterways
- slope
- soil
- earthquake
- landslide
- wave height
- surge height
- storm
- rainfall
- humidity
- wind speed
- flood
- drought / degredation

MAP OVERLAY INDEX

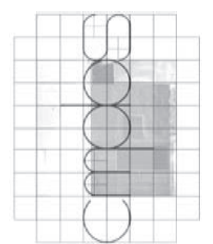
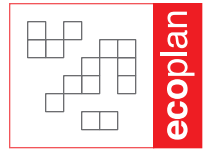
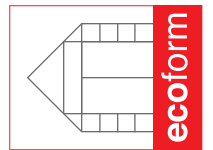
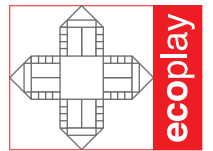
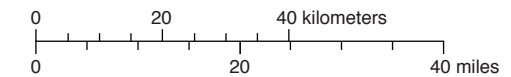
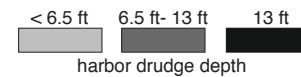
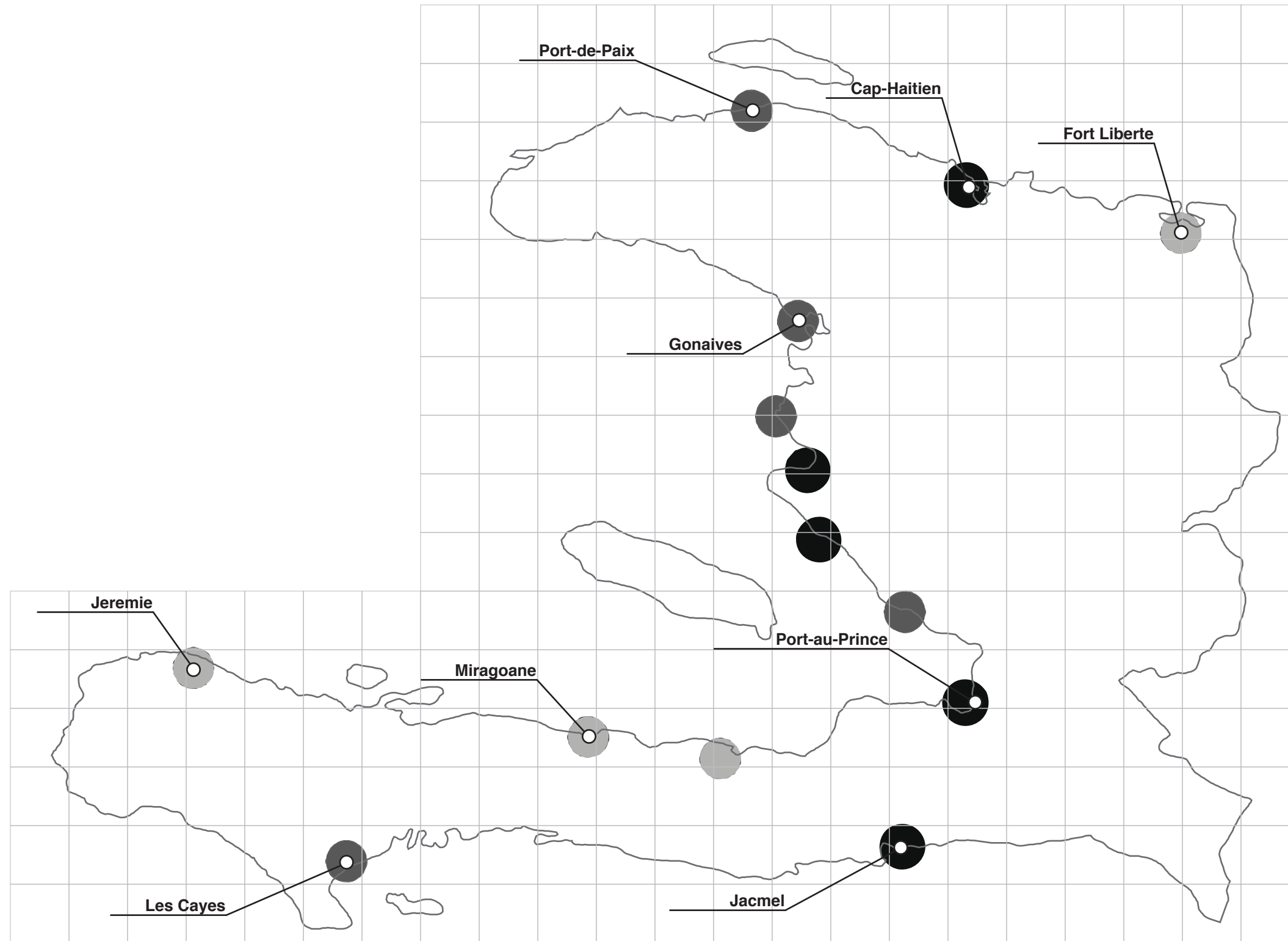

SUITABILITY ANALYSIS

Haiti Waterways

- topography
- urban area
- population density
- population displacement
- road infrastructure
- harbor locations
- **waterways**
- slope
- soil
- earthquake
- landslide
- wave height
- surge height
- storm
- rainfall
- humidity
- wind speed
- flood
- drought / degradation

MAP OVERLAY INDEX



waterways

0 20 40 kilometers
0 20 40 miles

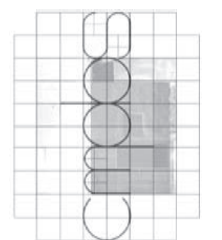
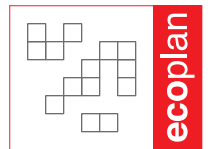
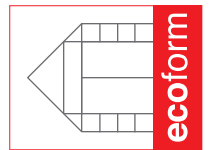
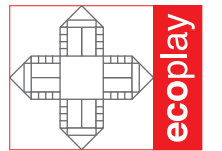

SUITABILITY ANALYSIS

Haiti Slope Analysis

Other than Haiti's three major plains, over 80% of the land area has a varying slope. These plains areas offer a land slope of less than 3%. A majority of the sloped land area can change from ranges of 3% to 47%. Along the three major mountain ranges cutting across Haiti, land slope can vary upwards of 47%.

The plains in Haiti offer the best opportunity with minimal foundation effort. The sloped areas of 3% to 47% may require significant foundation interventions. While the areas of greater than 47% slope would not be recommended for development.

- topography
- urban area
- population density
- populatin displacement
- road infrastructure
- harbor locations
- waterways
- **slope**
- soil
- earthquake
- landslide
- wave height
- surge height
- storm
- rainfall
- humidity
- wind speed
- flood
- drought / degredation

MAP OVERLAY INDEX

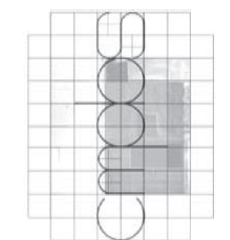
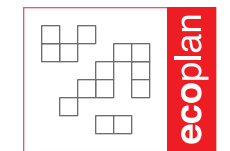
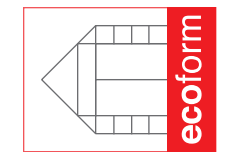
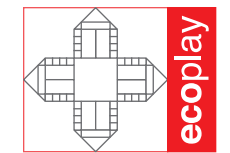
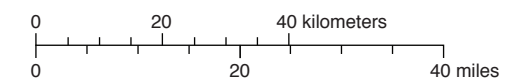
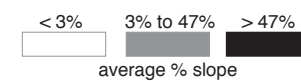
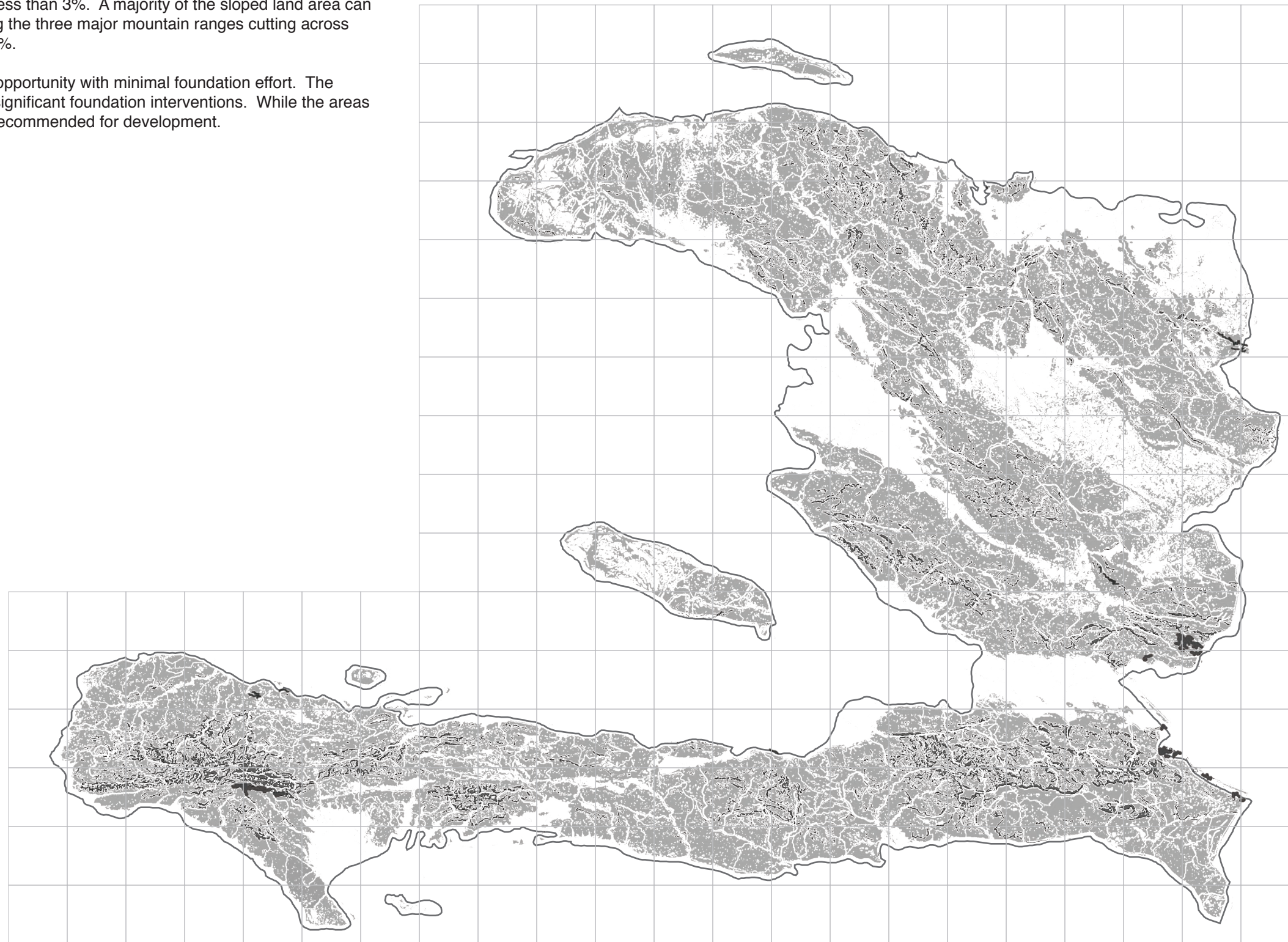

SUITABILITY ANALYSIS

Haiti Soil Suitability

- topography
- urban area
- population density
- population displacement
- road infrastructure
- harbor locations
- waterways
- slope
- **soil**
- earthquake
- landslide
- wave height
- surge height
- storm
- rainfall
- humidity
- wind speed
- flood
- drought / degradation

MAP OVERLAY INDEX

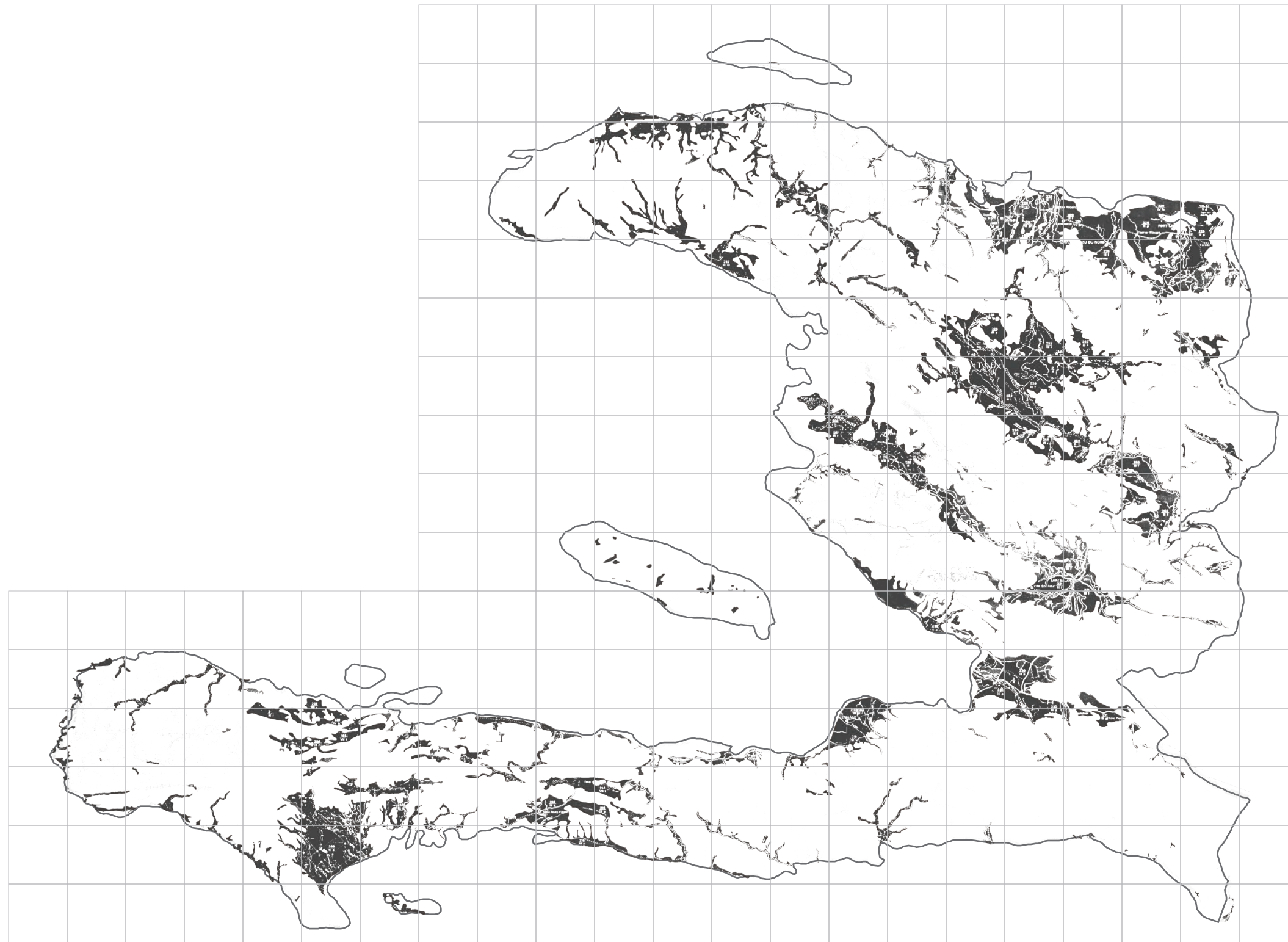

more
productive soil

0 20 40 kilometers
0 20 40 miles

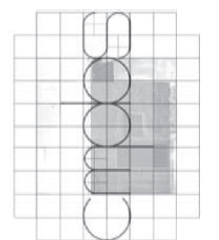
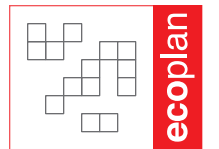
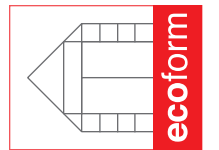
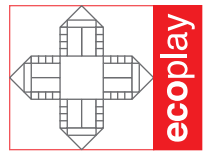

SUITABILITY ANALYSIS

Haiti Earthquake Propensity

- topography
- urban area
- population density
- populatin displacement
- road infrastructure
- harbor locations
- waterways
- slope
- soil

- earthquake

- landslide
- wave height
- surge height
- storm
- rainfall
- humidity
- wind speed
- flood
- drought / degredation

MAP OVERLAY INDEX

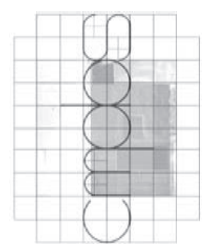
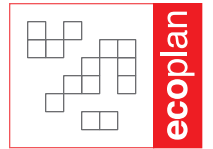
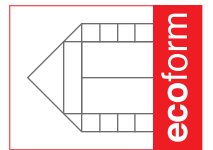
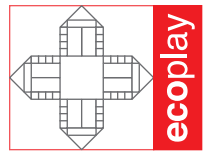
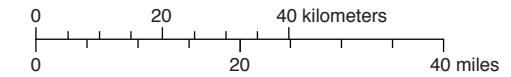
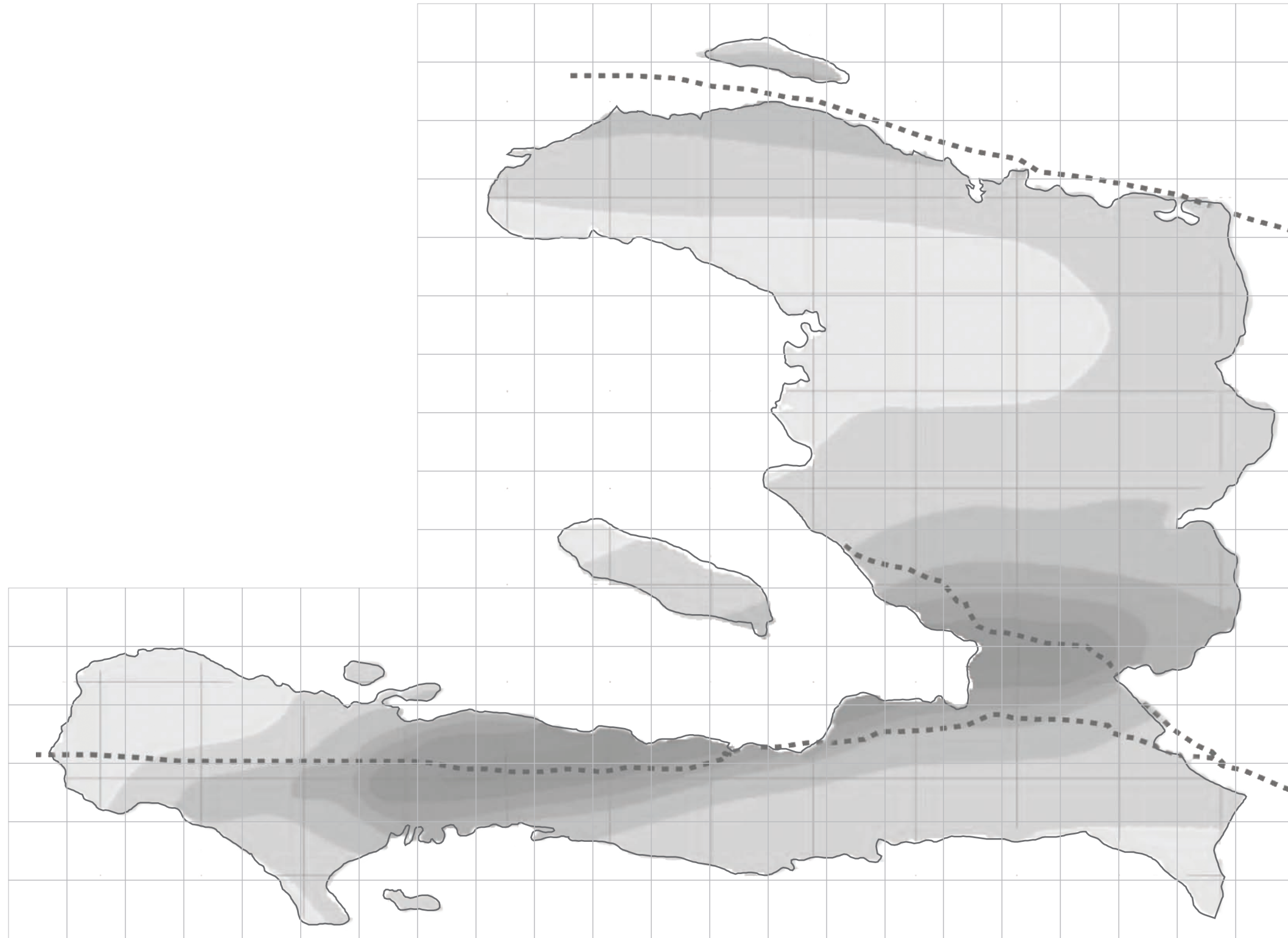

SUITABILITY ANALYSIS

Haiti Landslide Areas

- topography
- urban area
- population density
- populatin displacement
- road infrastructure
- harbor locations
- waterways
- slope
- soil
- earthquake
- **landslide**
- wave height
- surge height
- storm
- rainfall
- humidity
- wind speed
- flood
- drought / degredation

MAP OVERLAY INDEX

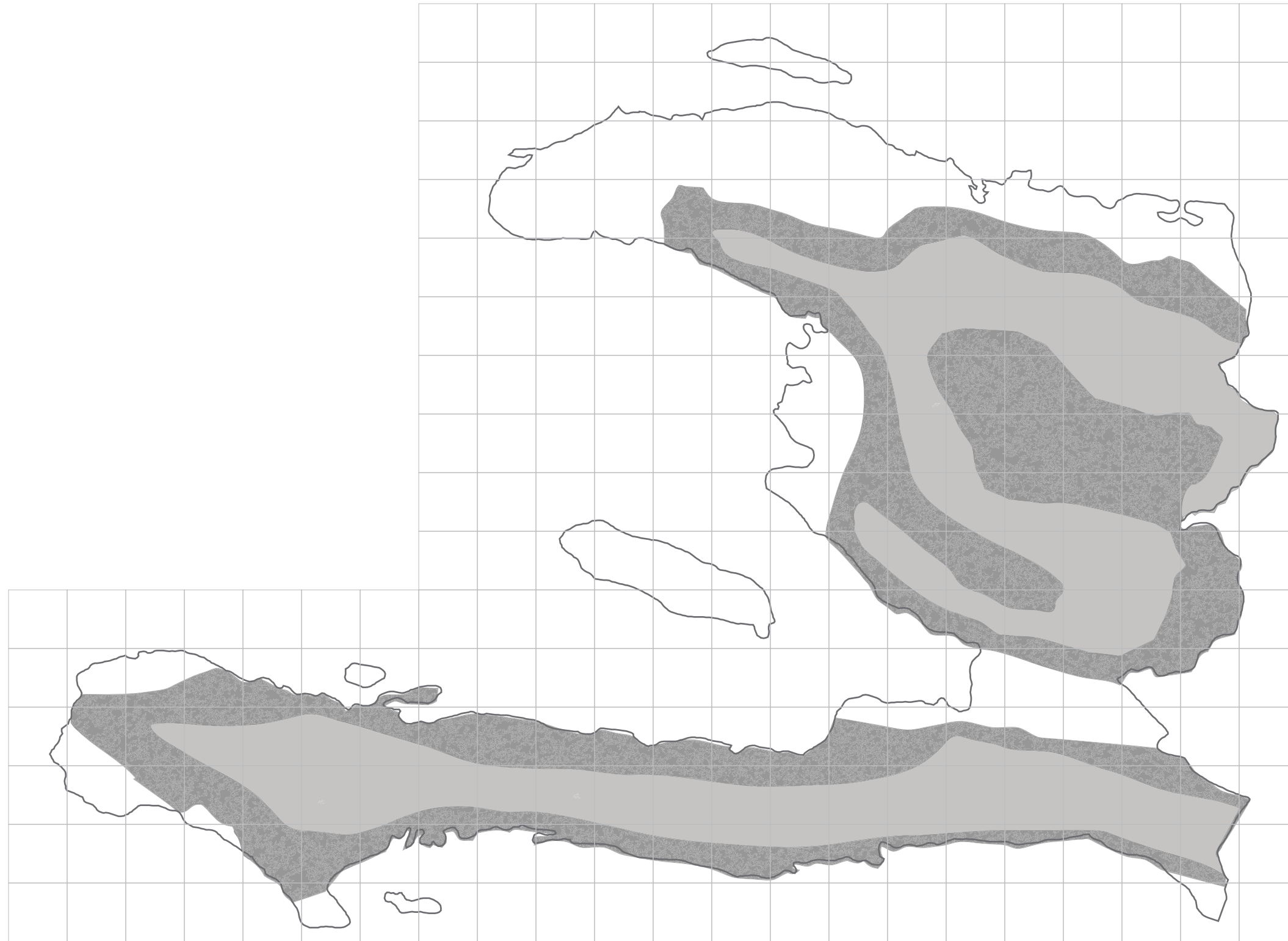

less greater
landslide prone area

0 20 40 kilometers
0 20 40 miles

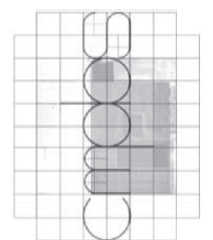
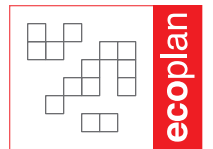
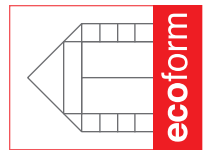
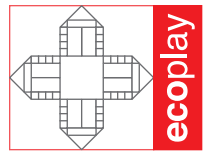

SUITABILITY ANALYSIS

Haiti Wave Height

- topography
- urban area
- population density
- population displacement
- road infrastructure
- harbor locations
- waterways
- slope
- soil
- earthquake
- landslide
- **wave height**
- surge height
- storm
- rainfall
- humidity
- wind speed
- flood
- drought / degradation

MAP OVERLAY INDEX

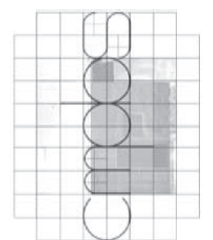
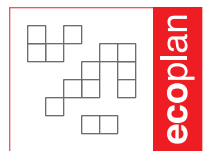
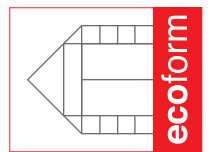
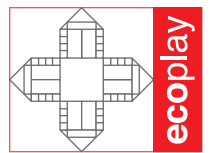
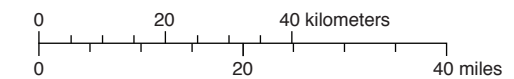
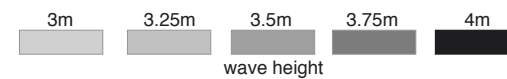

SUITABILITY ANALYSIS

Haiti Wave Surge Height

- topography
- urban area
- population density
- population displacement
- road infrastructure
- harbor locations
- waterways
- slope
- soil
- earthquake
- landslide
- wave height
- **surge height**
- storm
- rainfall
- humidity
- wind speed
- flood
- drought / degradation

MAP OVERLAY INDEX

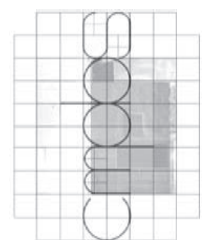
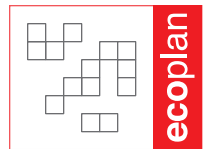
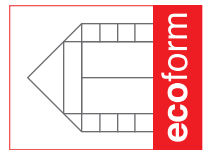
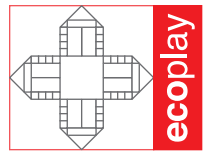

SUITABILITY ANALYSIS

Haiti Storm Intensity

- topography
- urban area
- population density
- population displacement
- road infrastructure
- harbor locations
- waterways
- slope
- soil
- earthquake
- landslide
- wave height
- surge height
- **storm**
- rainfall
- humidity
- wind speed
- flood
- drought / degradation

MAP OVERLAY INDEX

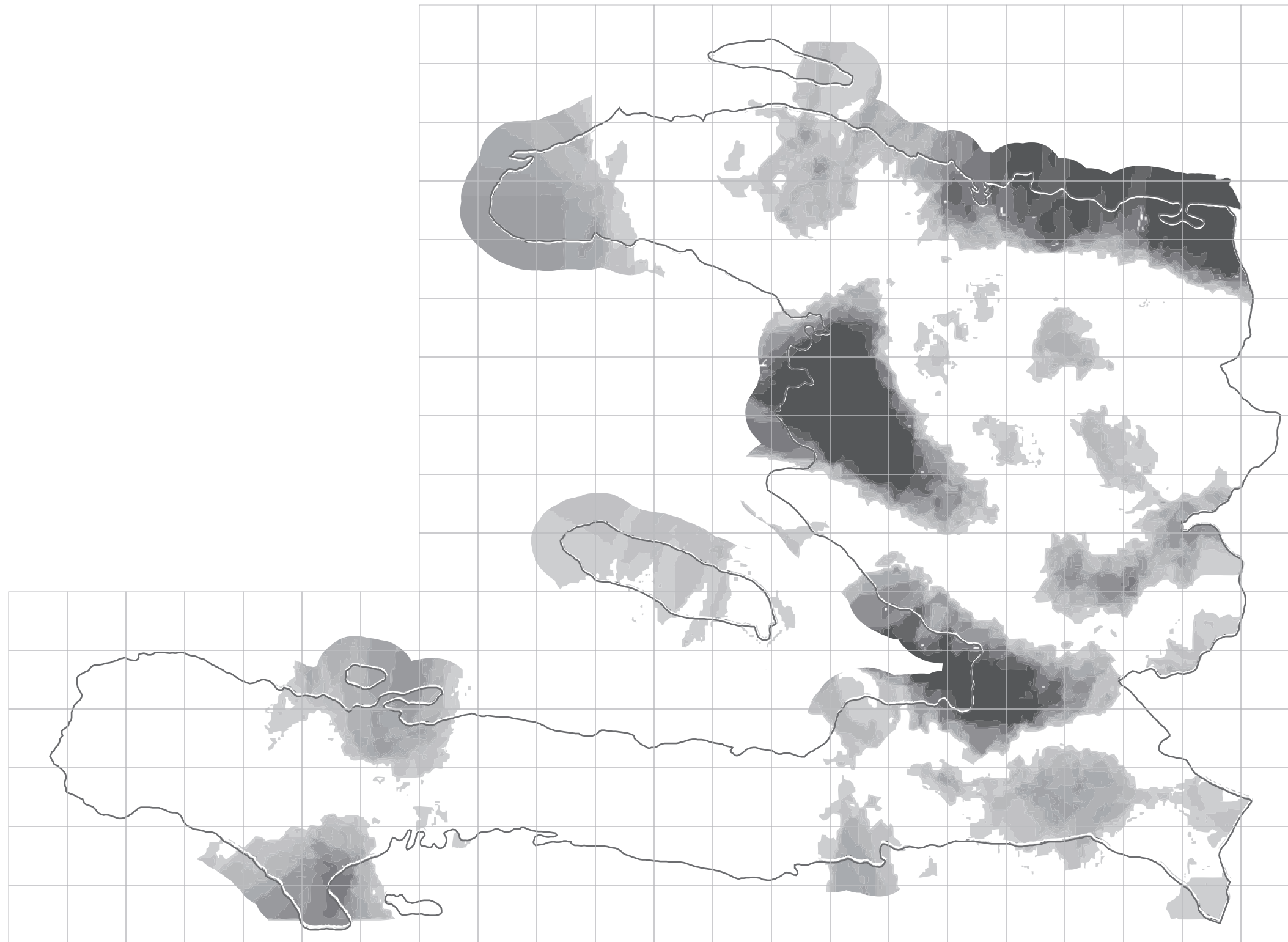

less moderate greater
average storm intensity

0 20 40 kilometers
0 20 40 miles

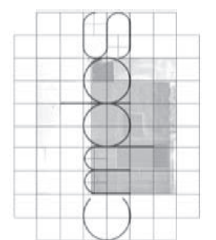
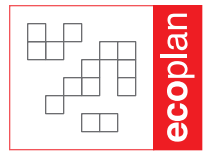
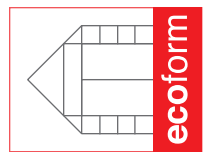
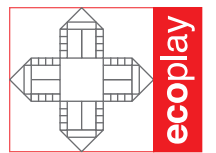

SUITABILITY ANALYSIS

Haiti Average Rainfall

- topography
- urban area
- population density
- population displacement
- road infrastructure
- harbor locations
- waterways
- slope
- soil
- earthquake
- landslide
- wave height
- surge height
- storm
- **rainfall**
- humidity
- wind speed
- flood
- drought / degradation

MAP OVERLAY INDEX

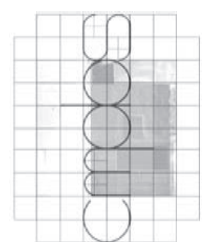
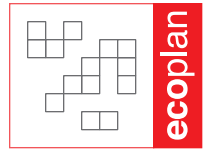
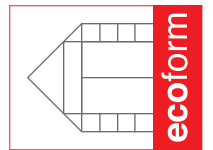
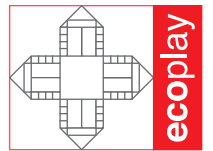
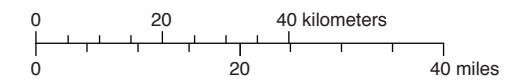
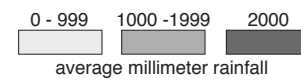
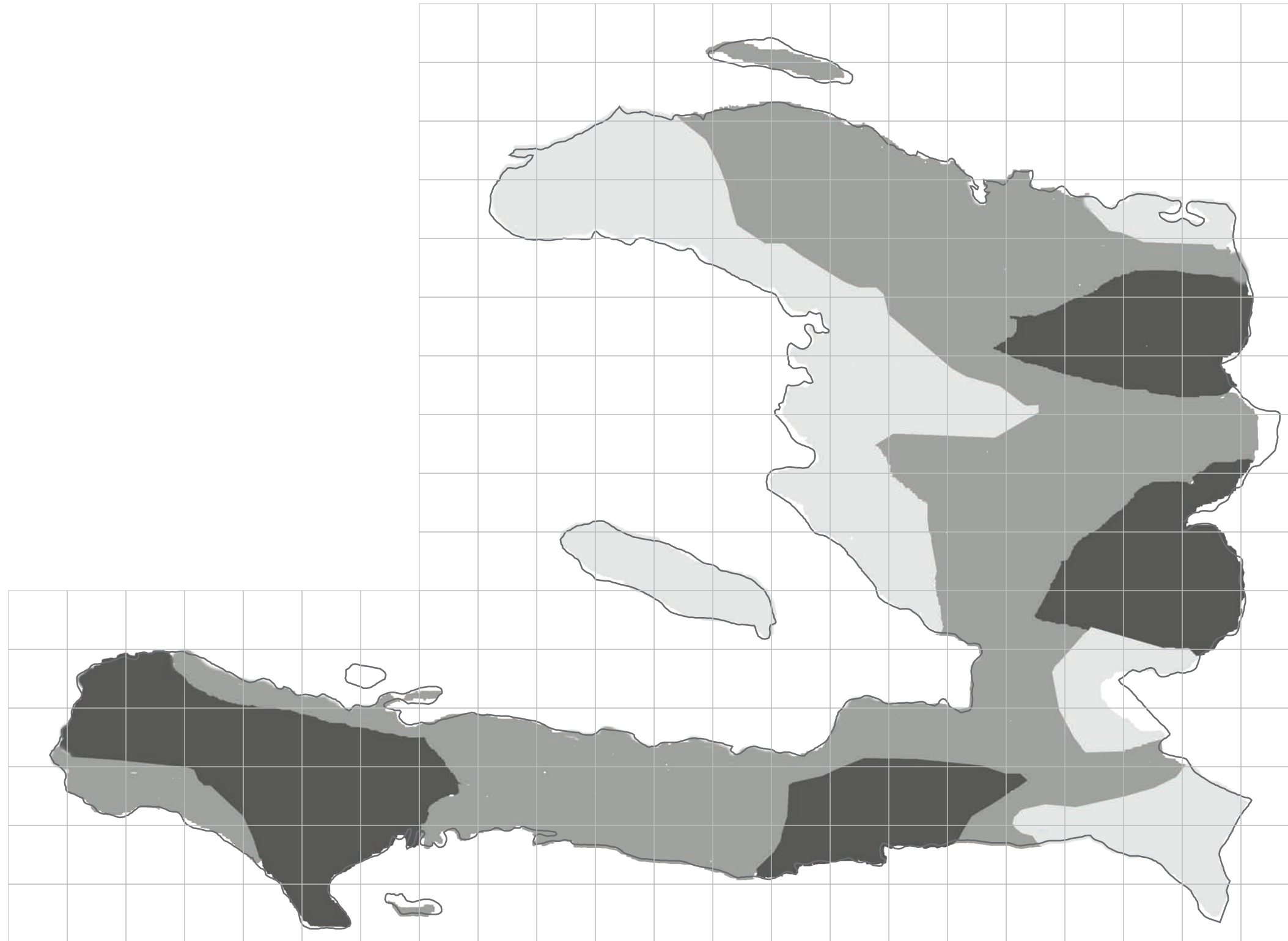

SUITABILITY ANALYSIS

Haiti Average Humidity

- topography
- urban area
- population density
- populatin displacement
- road infrastructure
- harbor locations
- waterways
- slope
- soil
- earthquake
- landslide
- wave height
- surge height
- storm
- rainfall
- **humidity**
- wind speed
- flood
- drought / degredation

MAP OVERLAY INDEX

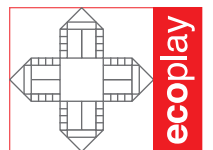
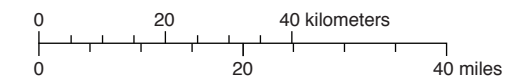
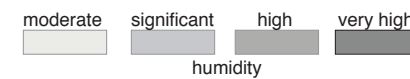

ecoplay

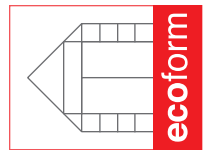

ecoform

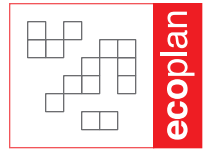

ecoplan



Island Nation Initiative

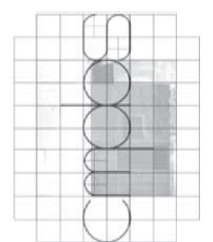

CIPUS

SUITABILITY ANALYSIS

Haiti Average Wind Speed

- topography
- urban area
- population density
- populatin displacement
- road infrastructure
- harbor locations
- waterways
- slope
- soil
- earthquake
- landslide
- wave height
- surge height
- storm
- rainfall
- humidity
- **wind speed**
- flood
- drought / degredation

MAP OVERLAY INDEX

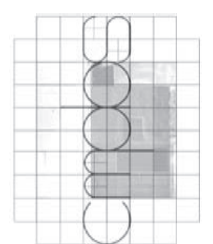
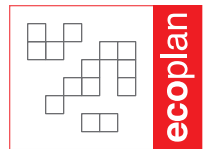
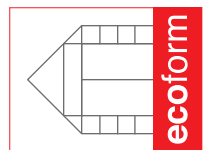
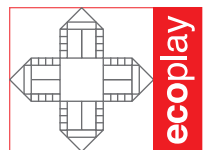
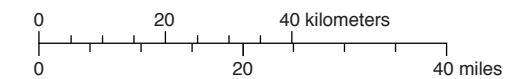
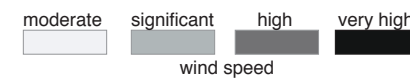

SUITABILITY ANALYSIS

Haiti Flood Areas

- topography
- urban area
- population density
- populatin displacement
- road infrastructure
- harbor locations
- waterways
- slope
- soil
- earthquake
- landslide
- wave height
- surge height
- storm
- rainfall
- humidity
- wind speed
- **flood**
- drought / degredation

MAP OVERLAY INDEX

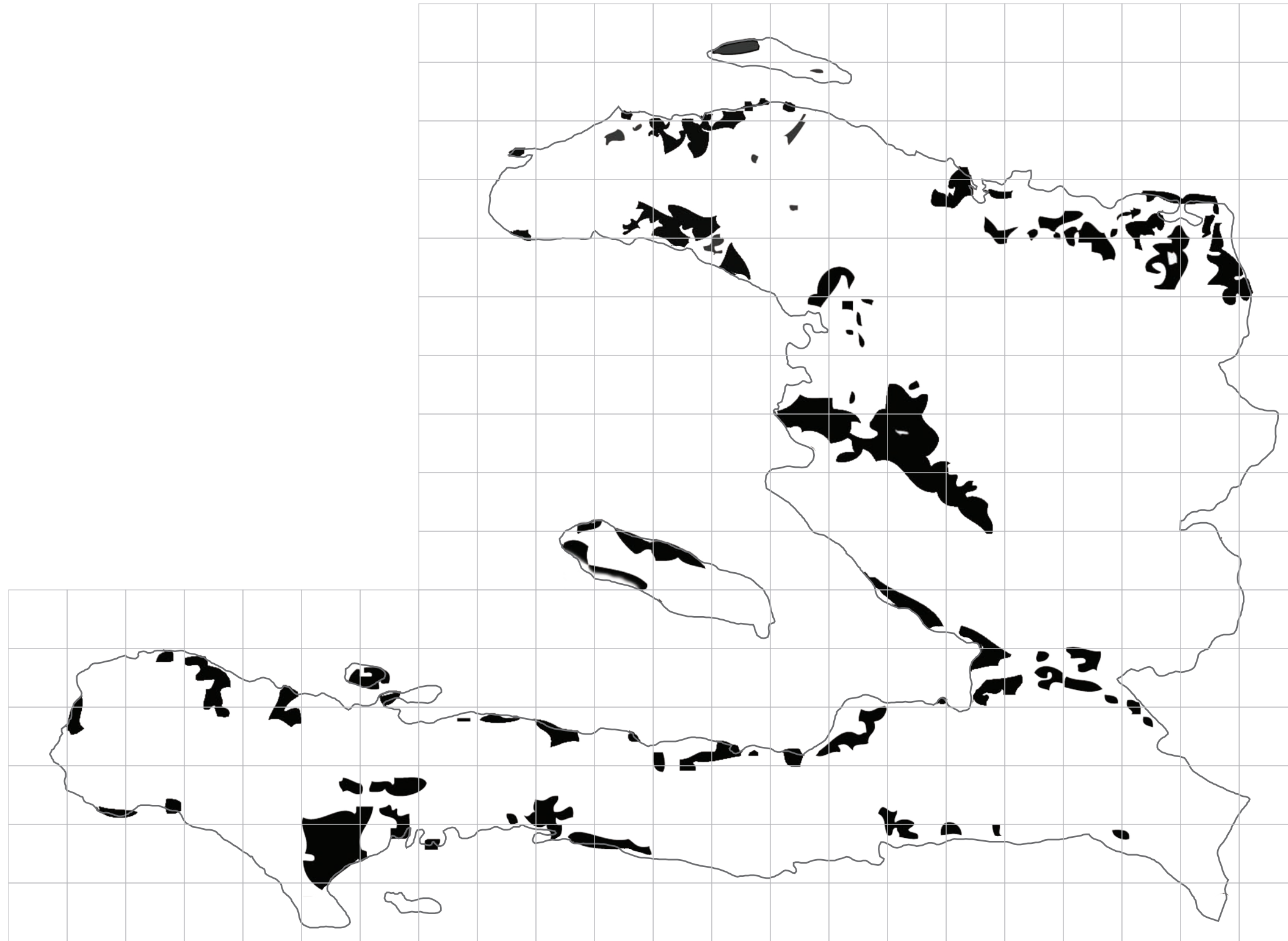

flood area

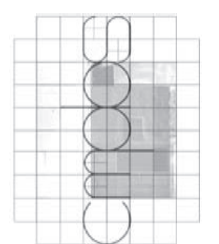
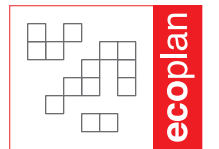
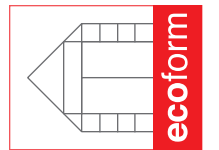
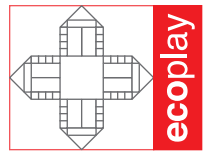
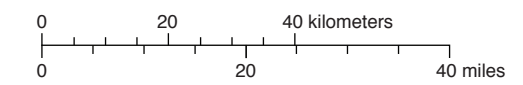

SUITABILITY ANALYSIS

Haiti Drought / Land Degredation

- topography
- urban area
- population density
- populatin displacement
- road infrastructure
- harbor locations
- waterways
- slope
- soil
- earthquake
- landslide
- wave height
- surge height
- storm
- rainfall
- humidity
- wind speed
- flood

- drought / degredation
MAP OVERLAY INDEX

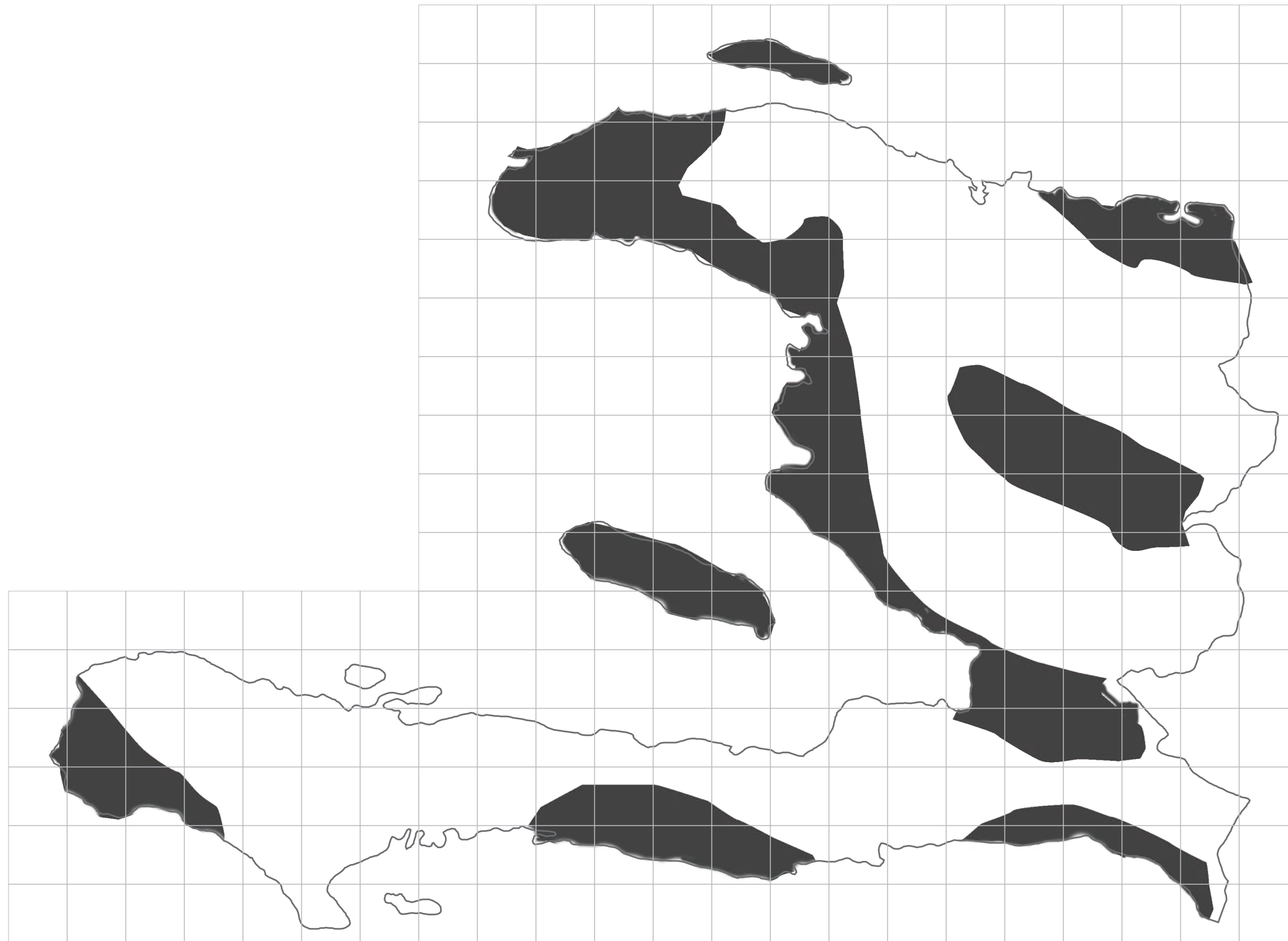

drought / degredation

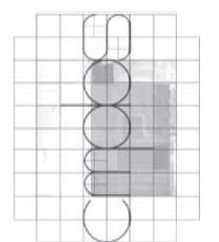
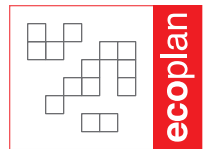
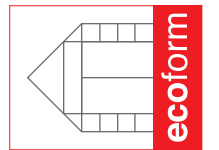
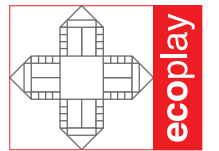
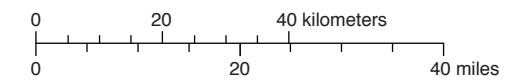

SUITABILITY ANALYSIS

Haiti Harbor Scenario

Harbor Scenario highlights potentially suitable areas for self-sufficient communities based on adjacency to harbors and infrastructure. The highlighted areas are 100 square mile quadrants of Haiti that seem to not be hindered by some of the mapped hazards and correlate well with existing, as well as essential, infrastructure (i.e. roads, ports, and urban areas).

- topography
- **urban area**
- population density
- population displacement
- **road infrastructure**
- **harbor locations**
- **waterways**
- **slope**
- **soil**
- earthquake
- **landslide**
- wave height
- surge height
- **storm**
- **rainfall**
- humidity
- wind speed
- flood
- drought / degradation

MAP OVERLAY INDEX

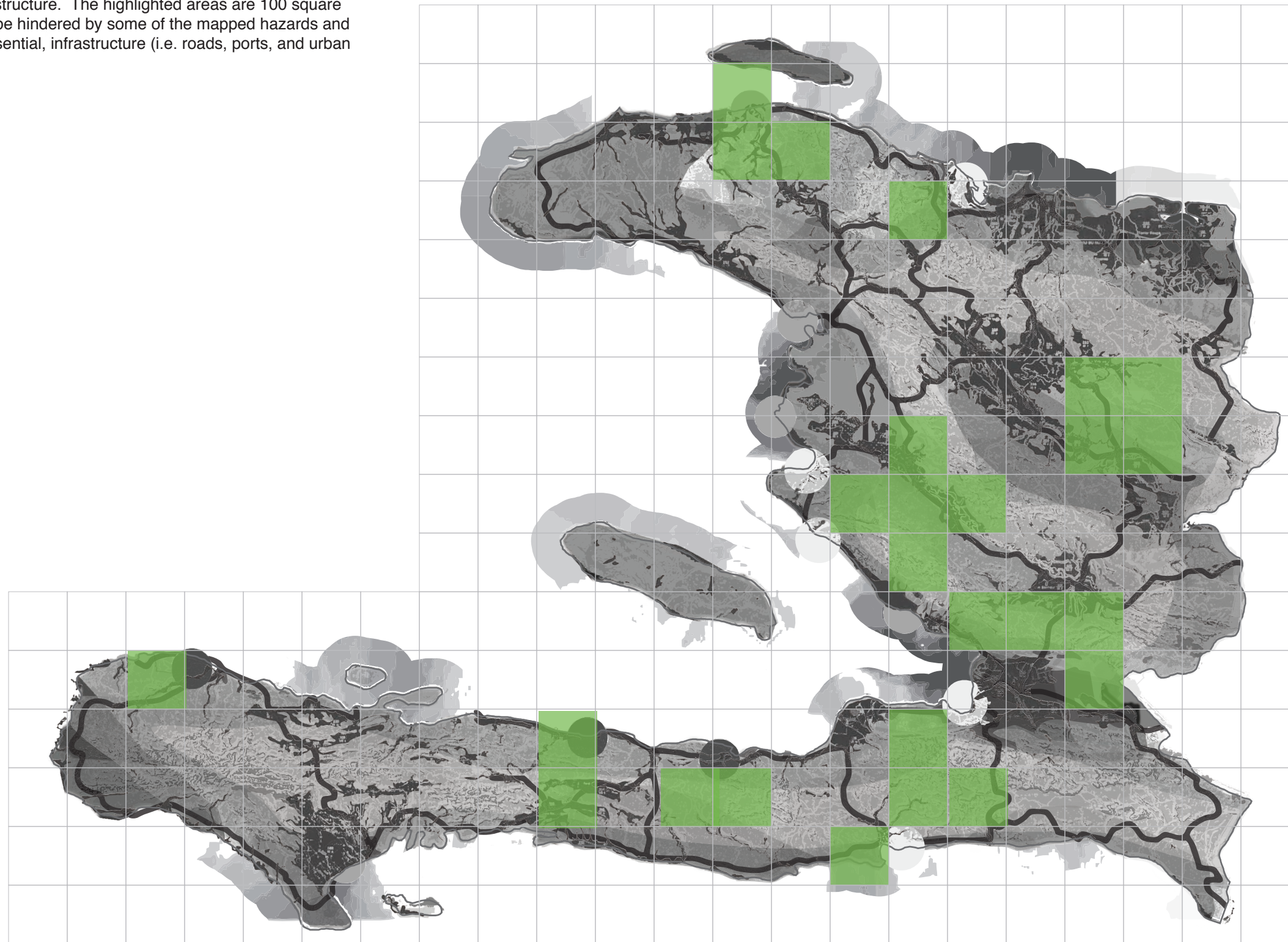

 suitable area

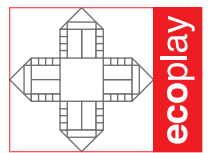
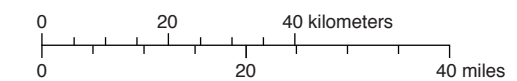

ecoplay

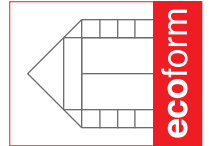

ecoform

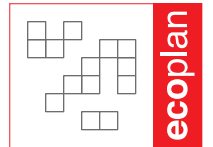

ecoplan



Island Nation Initiative

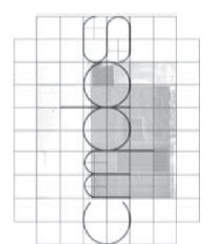

CIPUS

SUITABILITY ANALYSIS

Haiti Disaster Avoidance Scenario

Disaster Avoidance Scenario highlights potentially suitable areas for self-sufficient communities based on minimal impact from natural forces. The highlighted areas are 100 square mile quadrants of Haiti that seem to not be hindered by some of the mapped hazards such as earthquake propensity, surge height, landslide, etc.

- topography
 - urban area
 - population density
 - population displacement
 - road infrastructure
 - harbor locations
 - waterways
 - slope
 - soil
 - **earthquake**
 - **landslide**
 - wave height
 - **surge height**
 - **storm**
 - **rainfall**
 - humidity
 - **wind speed**
 - **flood**
 - **drought / degradation**
- MAP OVERLAY INDEX

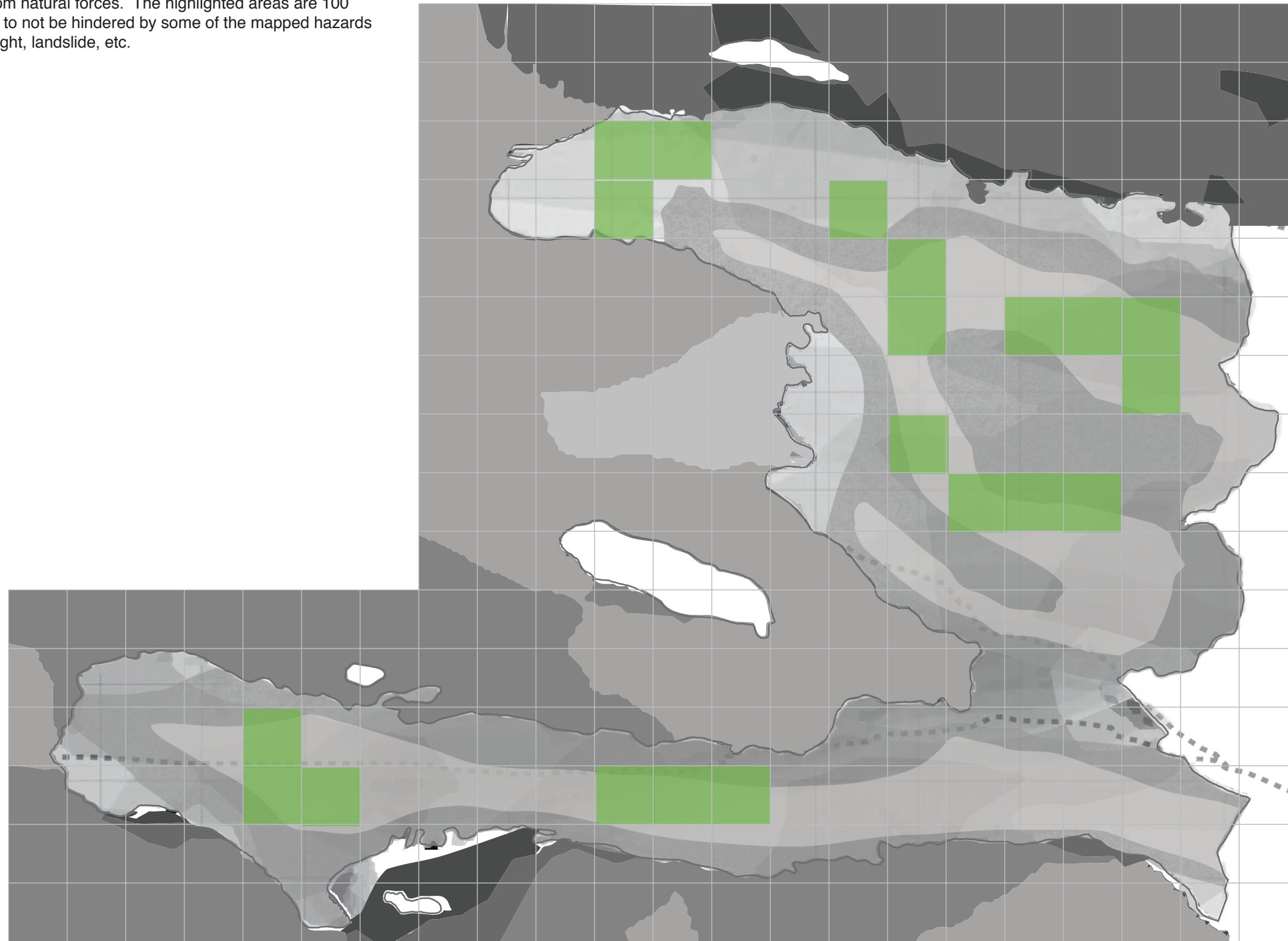

 suitable area

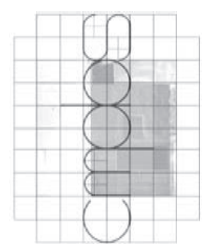
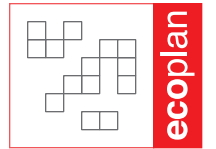
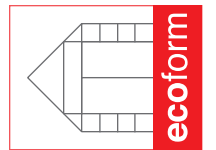
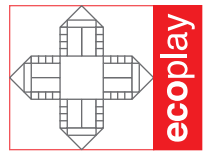
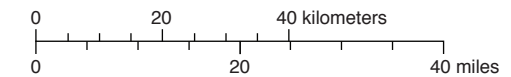

SUITABILITY ANALYSIS

Haiti Urban Relief Scenario

Urban Relief Scenario highlights potentially suitable areas for self-sufficient communities based on adjacency to urban areas and location of displaced persons. The highlighted areas are 100 square mile quadrants of Haiti that seem to be located near urban infrastructure and harbors to deliver materials and be placed on or near more productive soils.

- topography
- **urban area**
- population density
- **population displacement**
- **road infrastructure**
- **harbor locations**
- **waterways**
- **slope**
- **soil**
- earthquake
- landslide
- wave height
- surge height
- storm
- rainfall
- humidity
- wind speed
- flood
- drought / degradation

MAP OVERLAY INDEX

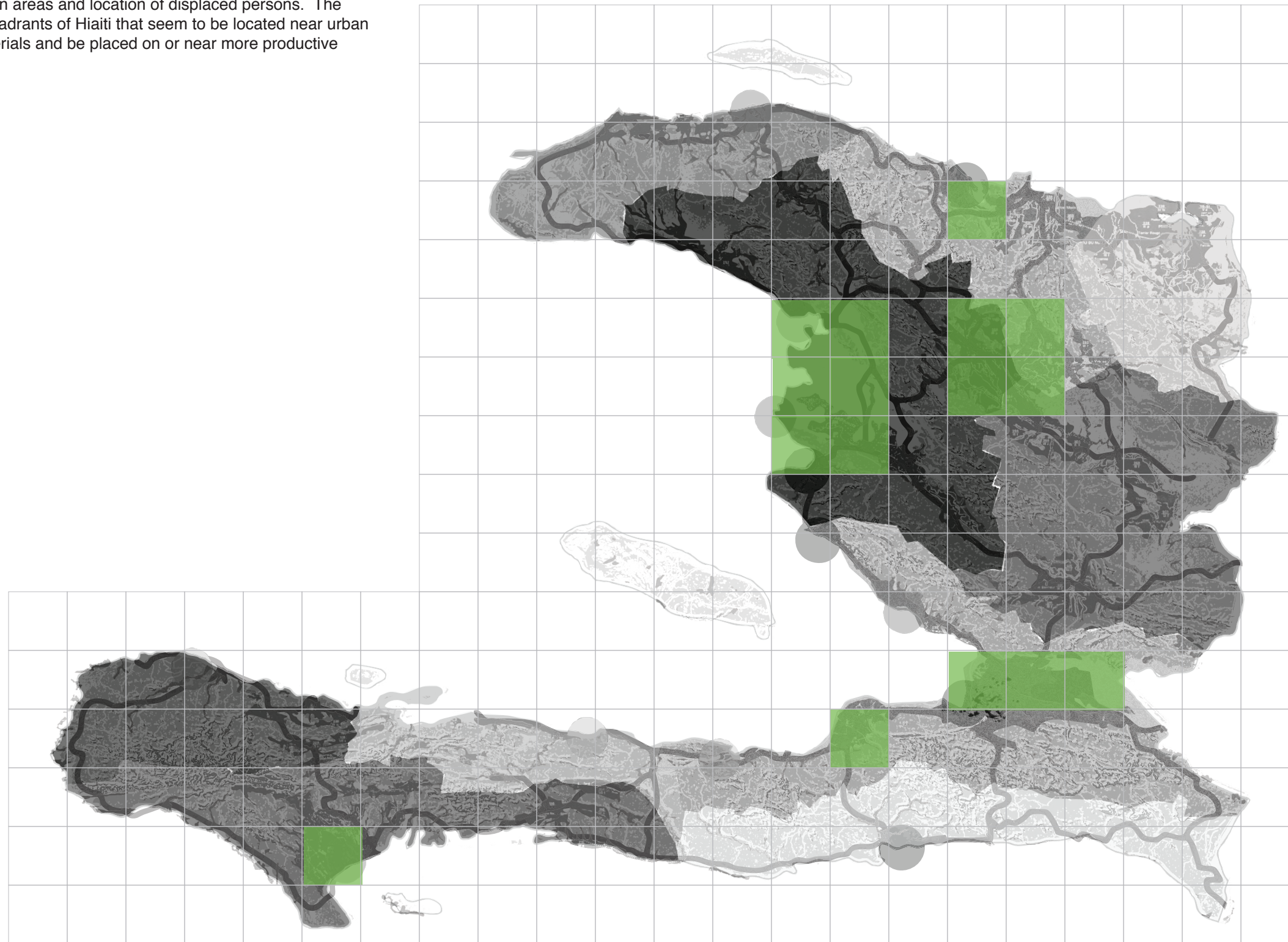

 suitable area

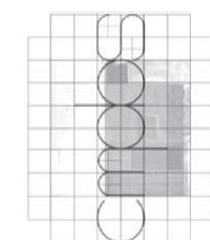
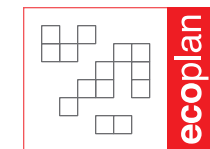
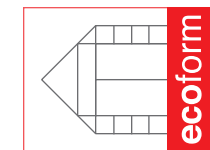
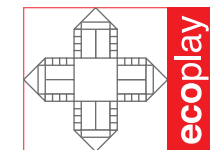
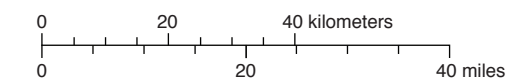

SUITABILITY ANALYSIS

Haiti Reparative Scenario

Reparative Scenario highlights potentially suitable areas for self-sufficient communities based on damaged or otherwise potentially not suitable land to be repaired. The highlighted areas are 100 square mile quadrants of Haiti that seem to be located near poorly productive soil and may be prone to landslides.

- topography
- **urban area**
- population density
- **population displacement**
- **road infrastructure**
- **harbor locations**
- **waterways**
- **slope**
- **soil**
- earthquake
- landslide
- wave height
- surge height
- storm
- rainfall
- humidity
- wind speed
- flood
- drought / degradation

MAP OVERLAY INDEX

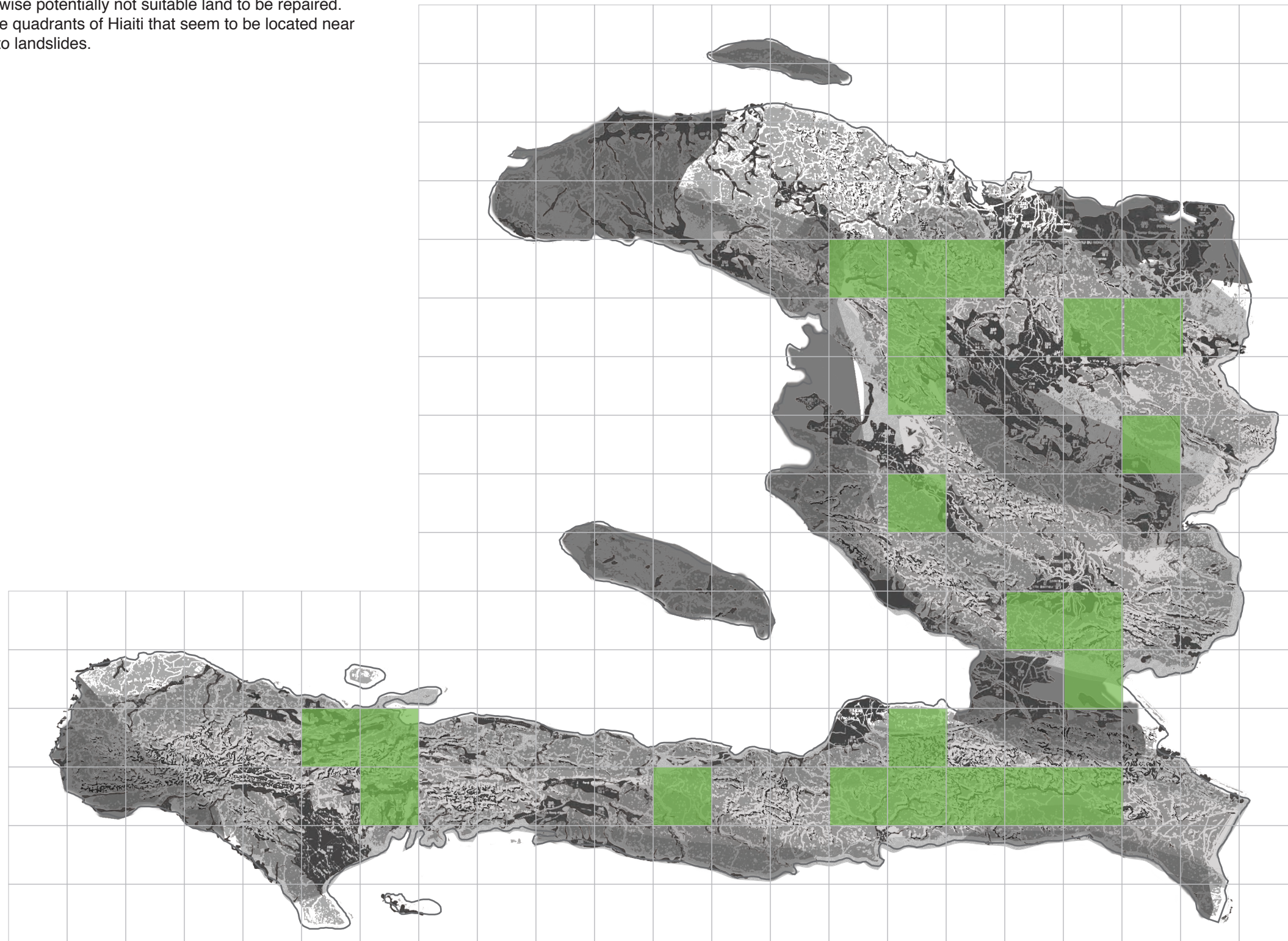

 suitable area

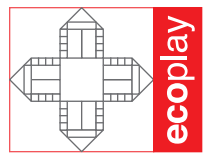
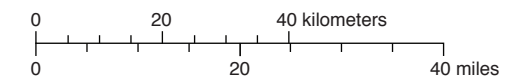

ecoplay

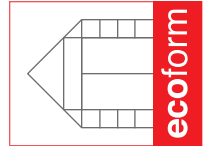

ecoform

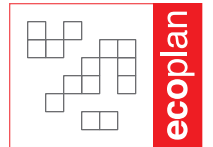

ecoplan



Island Nation Initiative

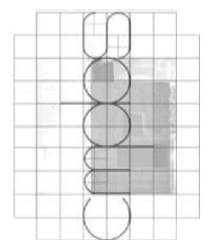

GROFORM™ MODULE

Suitability scenarios - bioclimatic adaptive strategies

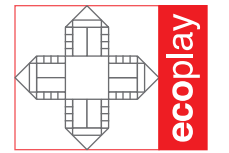
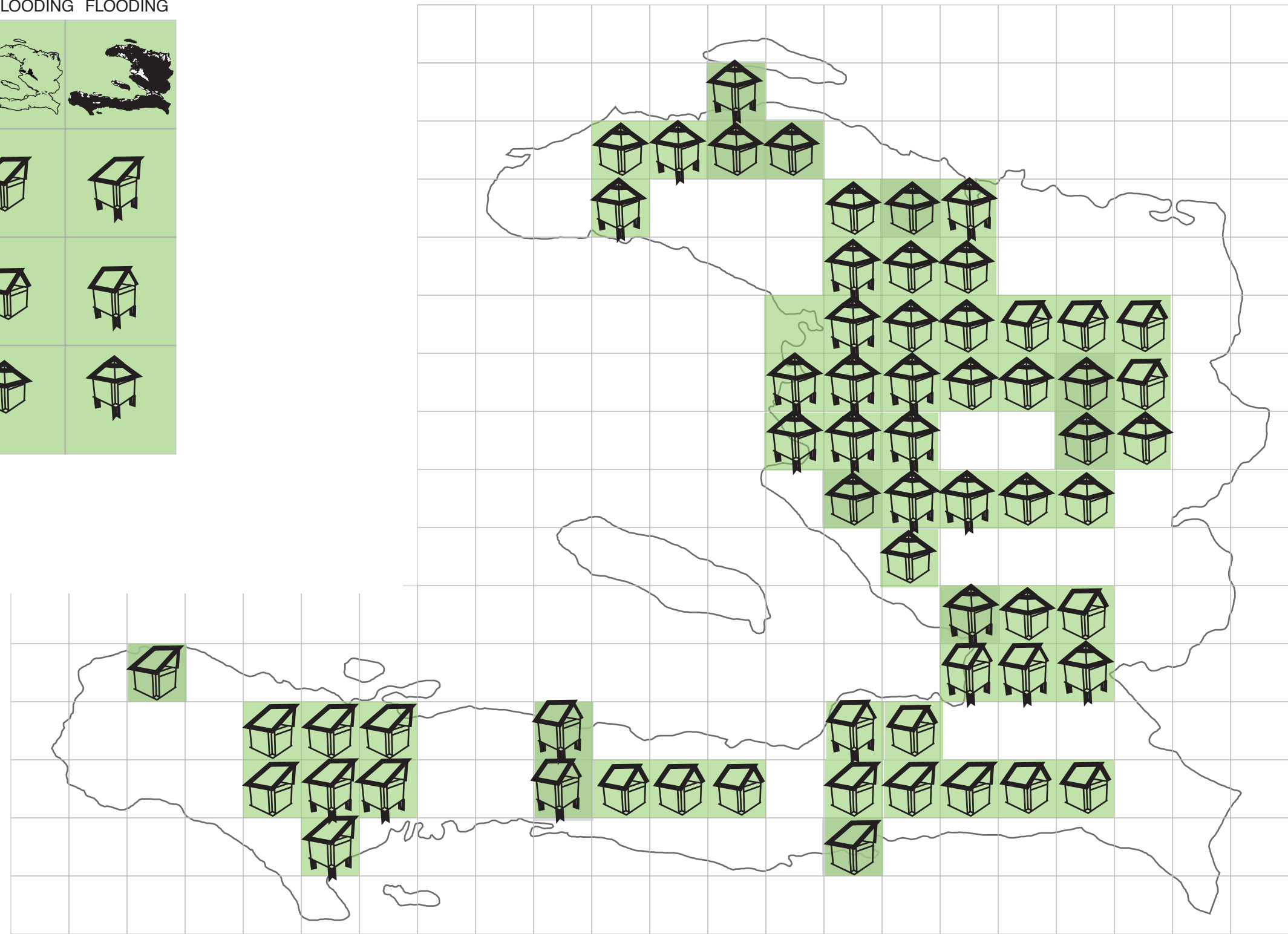
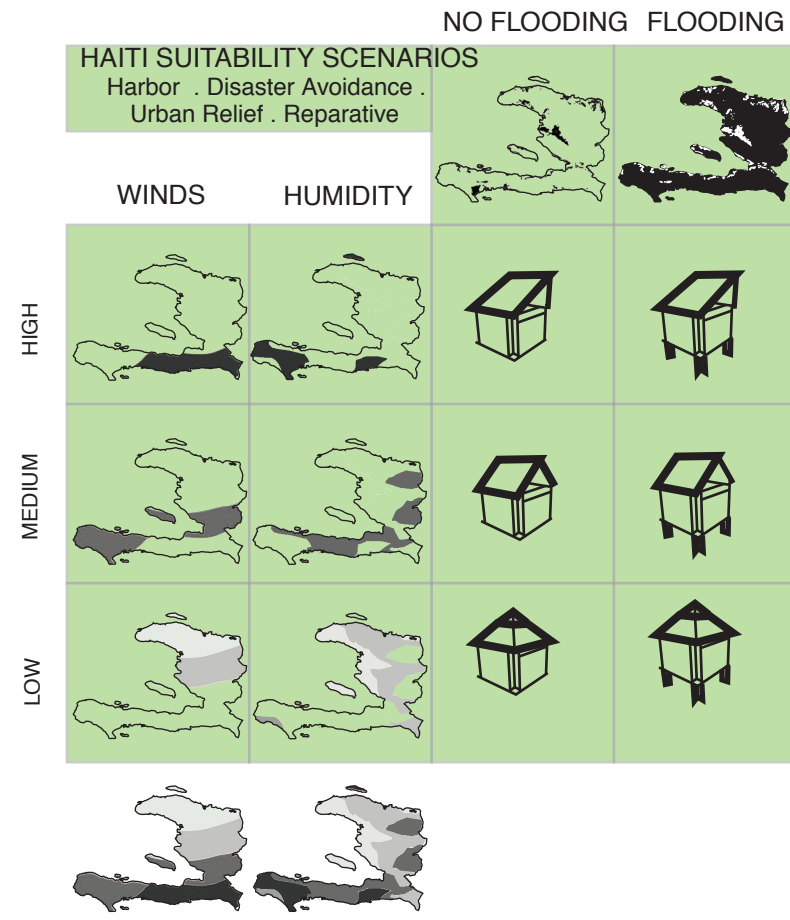

ecoplay

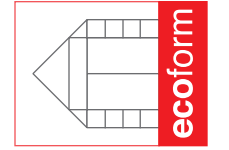

ecoform

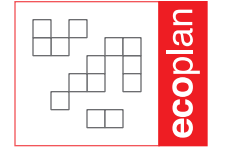

ecoplan



Island Nation Initiative

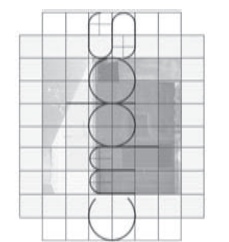

HAITI HOUSE

Typical Village Center

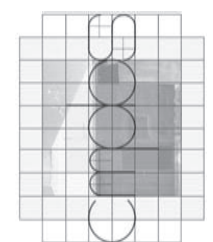
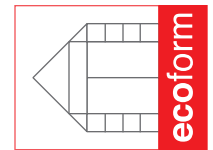
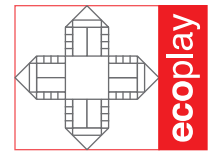

THE SITE

10 Rue L Union

Carrefour Mariani

HAITI

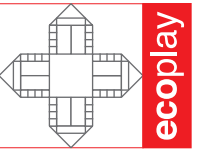
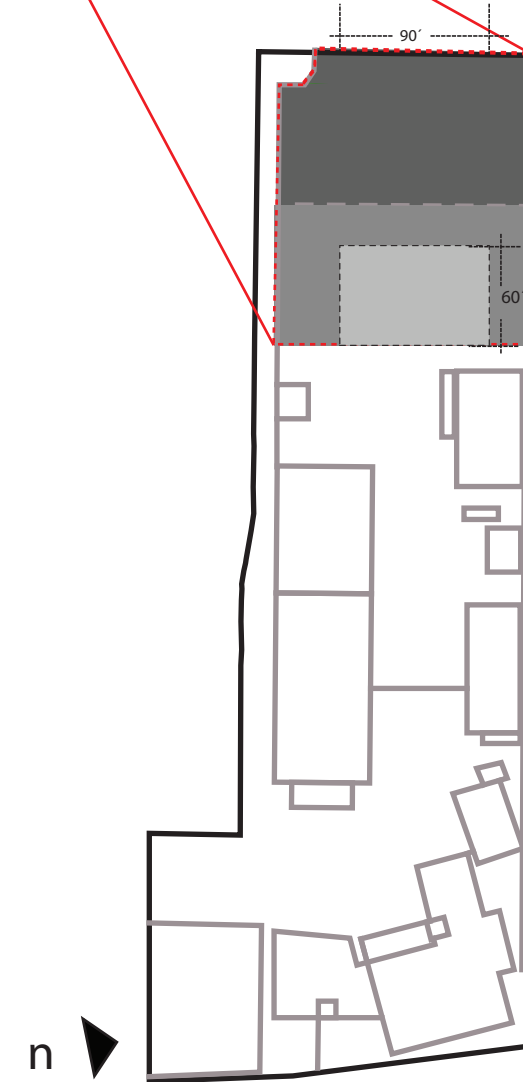

ecoplay

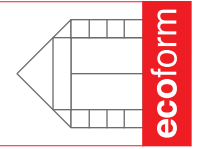

ecoform

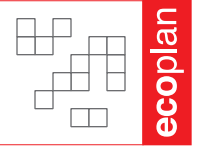

ecoplan



Island Nation Initiative

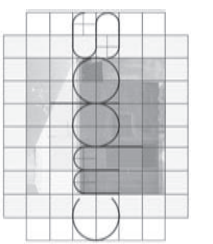

CROSS

BUILDING COMMUNITY

PHASE 1

60X90
7 BUILDINGS
14 PEOPLE

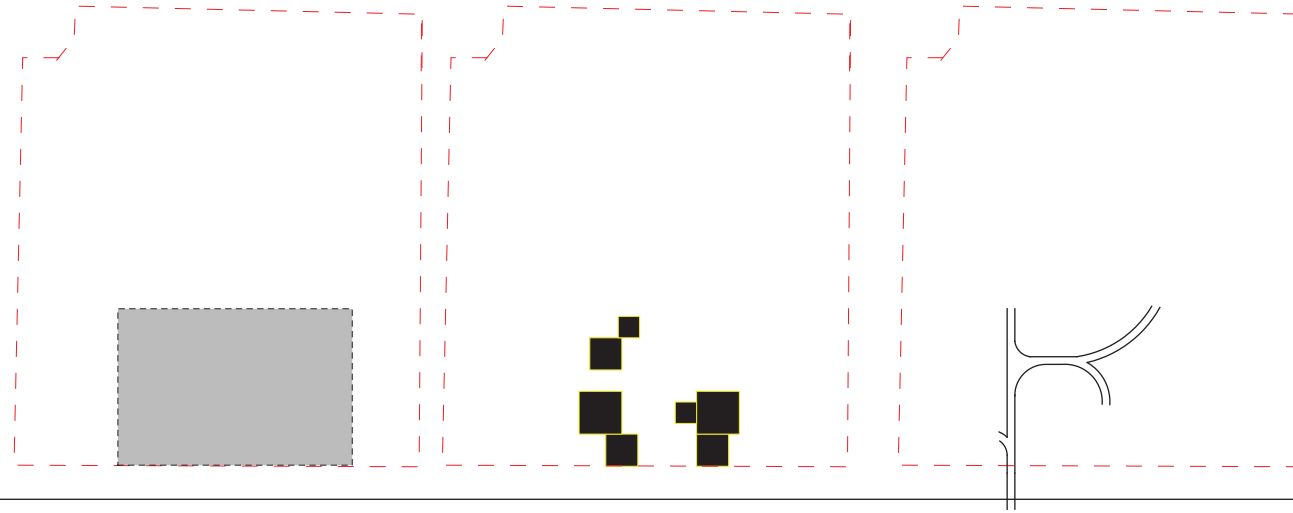
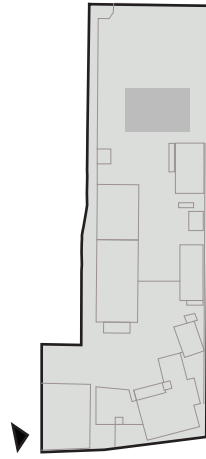

PHASE 2

100X148
28 BUILDINGS
56 PEOPLE

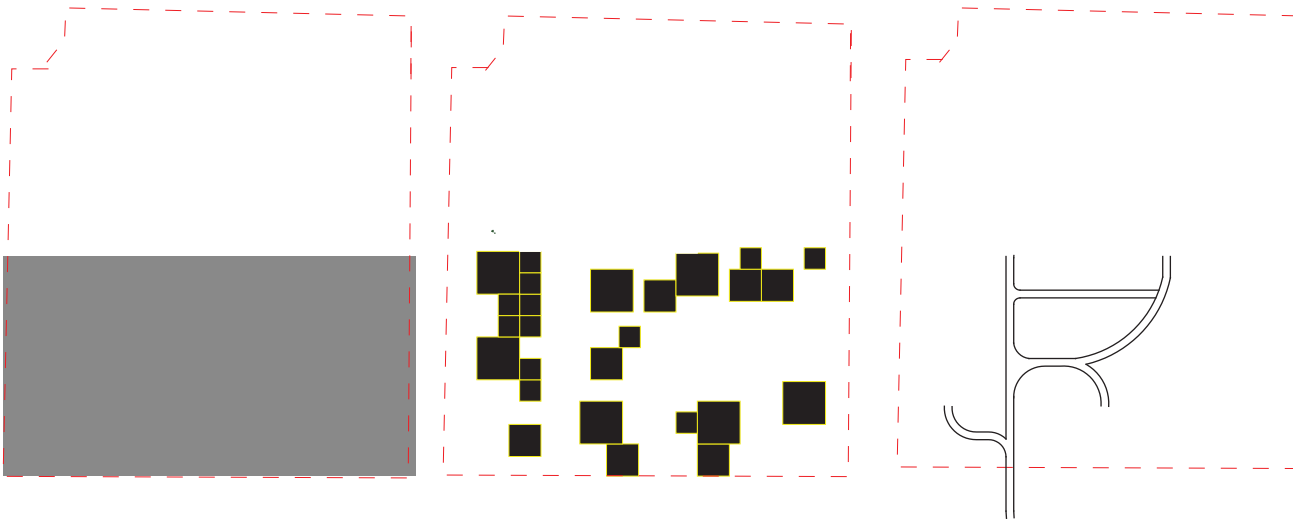

PHASE 3

148X190
57 BUILDINGS
114 PEOPLE

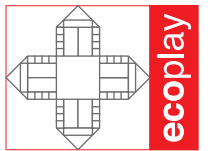
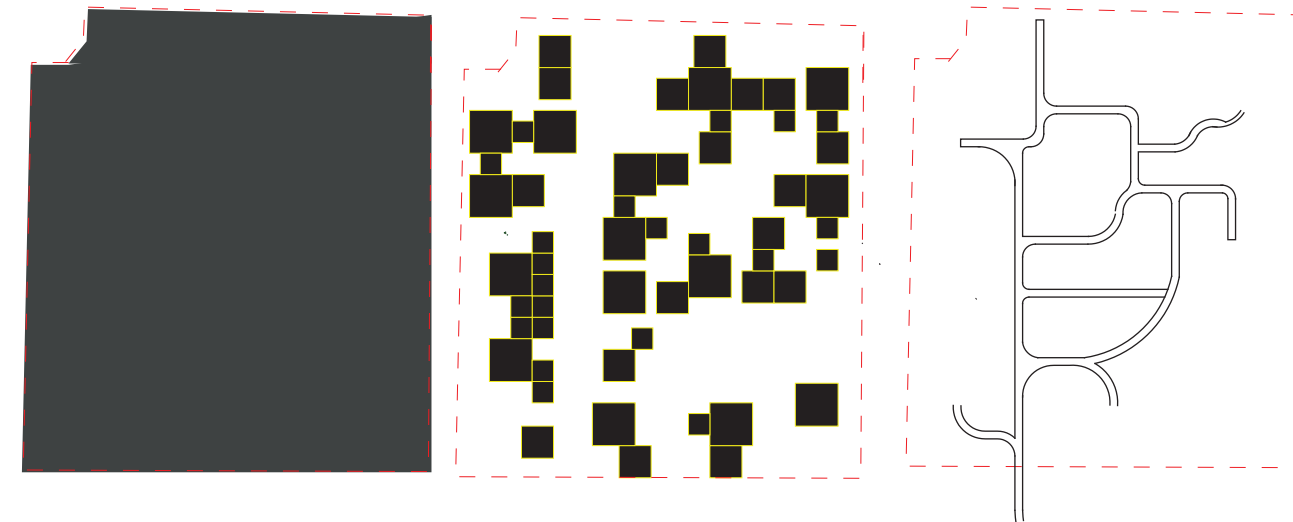
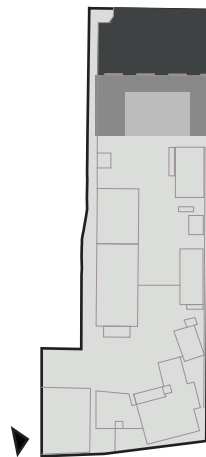

ecoplay

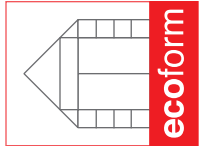

ecoform

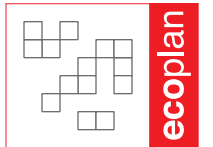

ecoplan



Island Nation Initiative

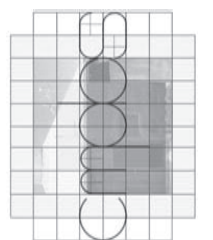

COMMUNITY PLAN

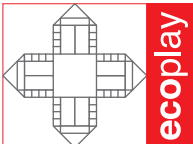
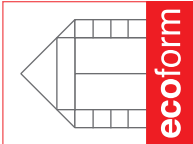
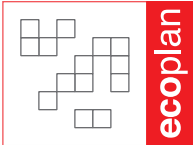
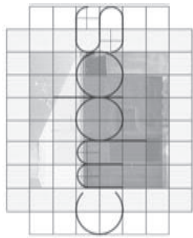
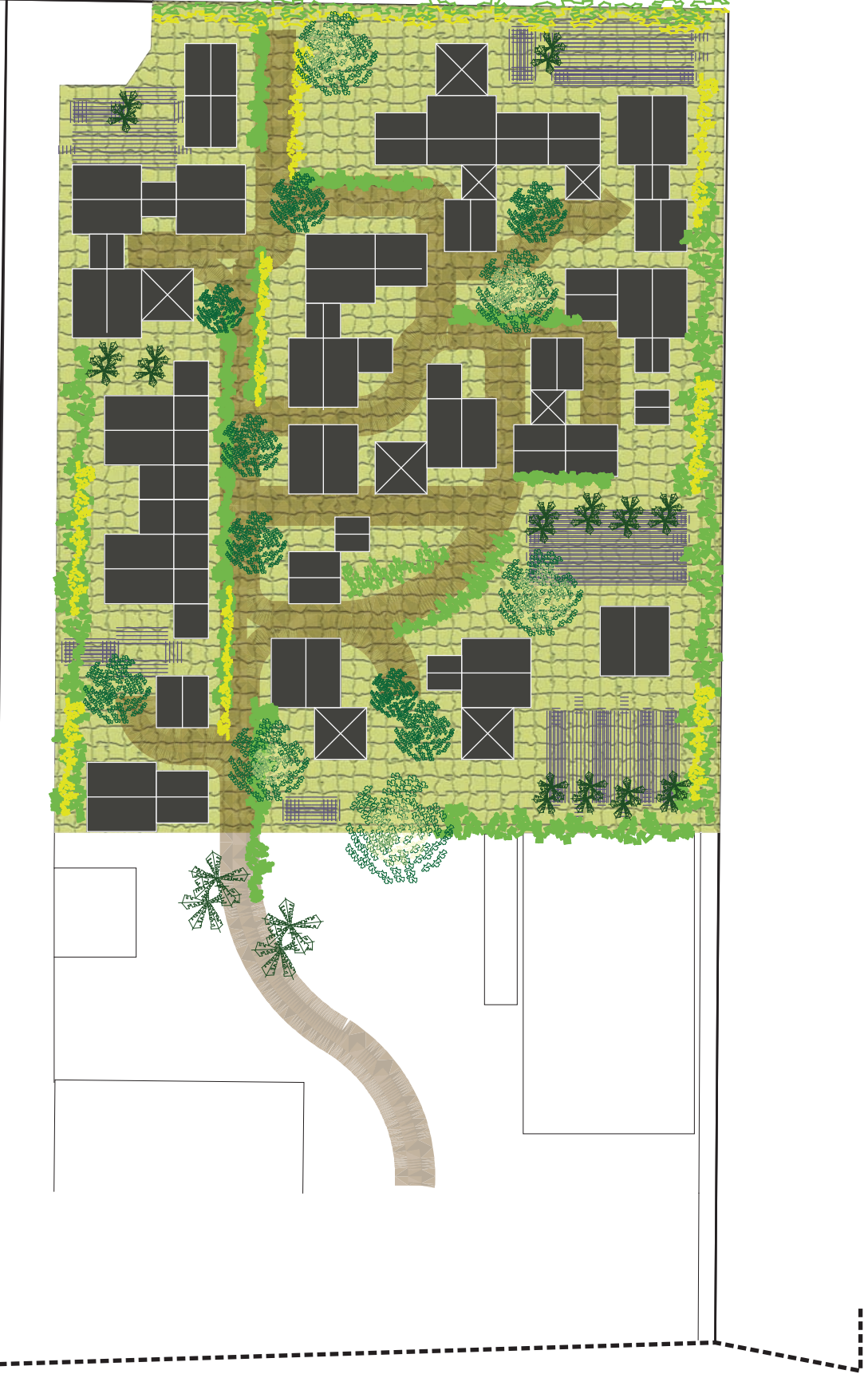
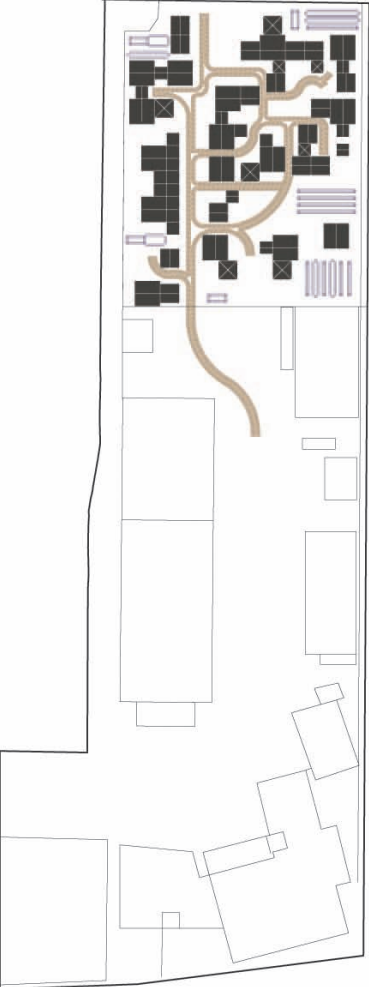

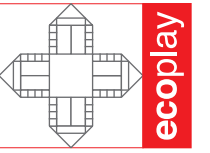

ecoplay

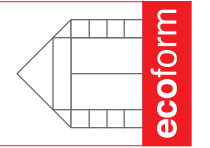

ecoform

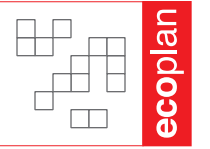

ecoplan

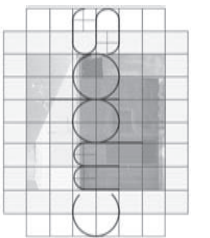

HAITI HOUSE

TENT OPTIONS

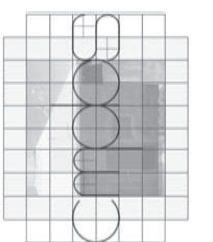
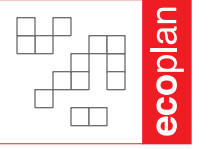
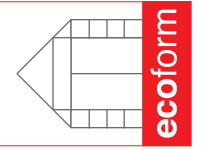
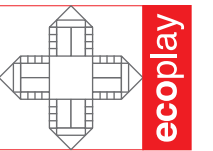
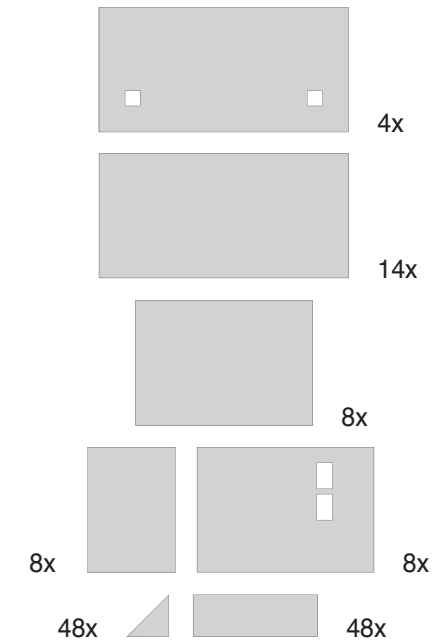
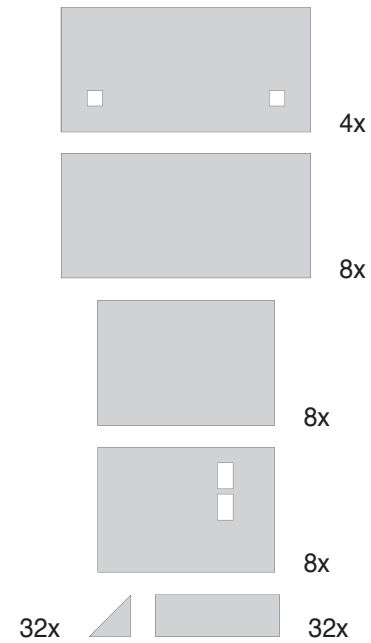
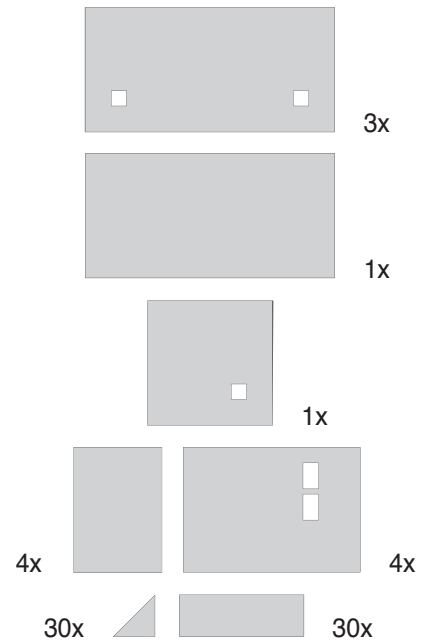
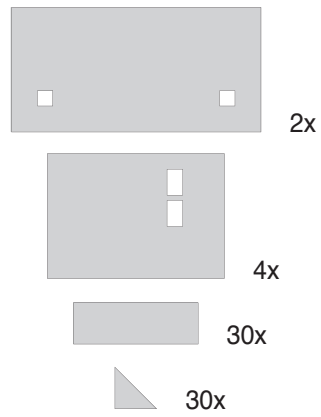
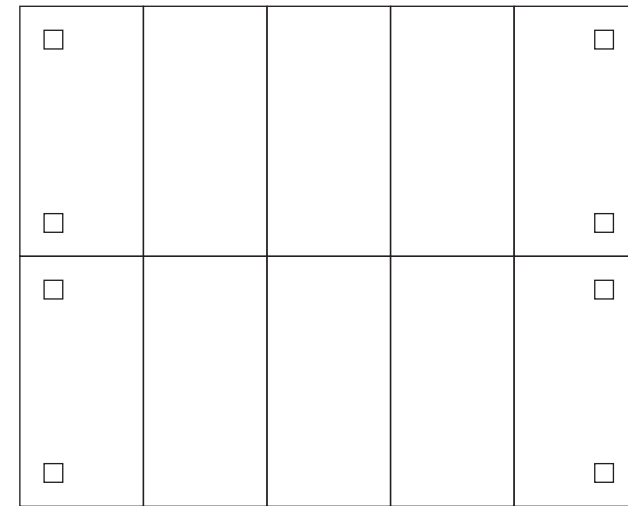
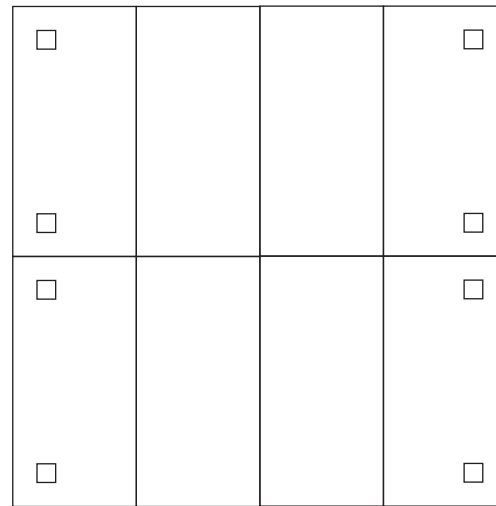
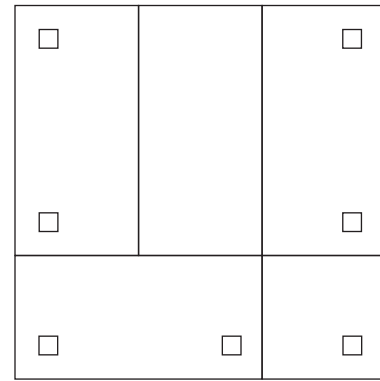
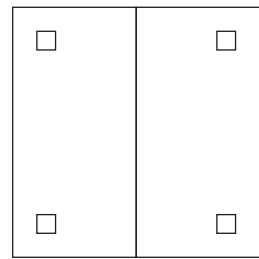
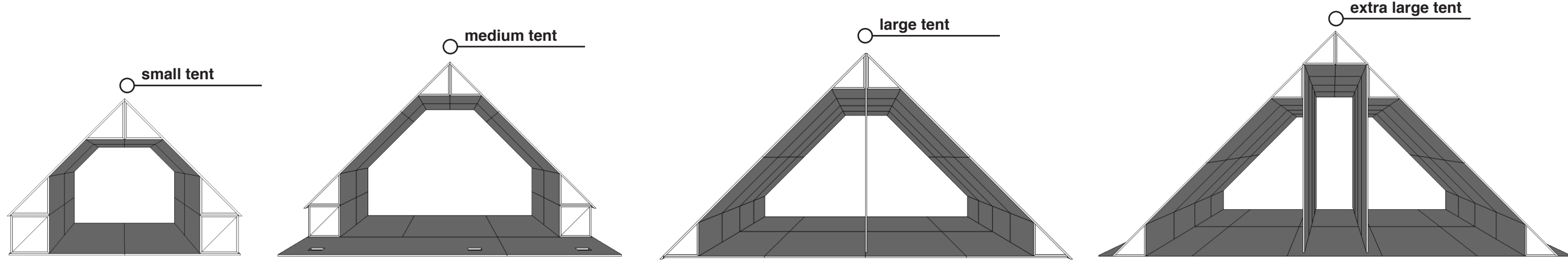

HAITI HOUSE

8 foot module

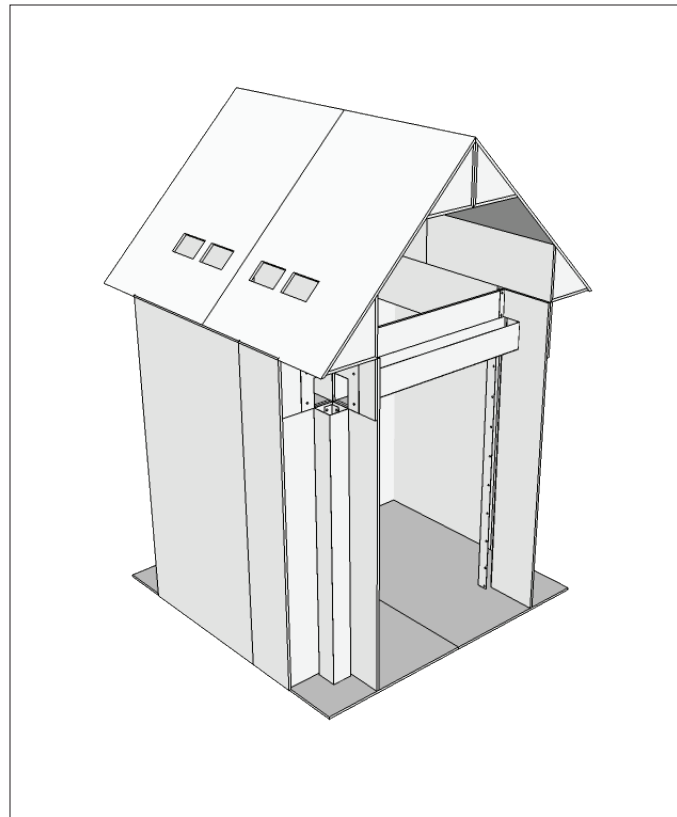
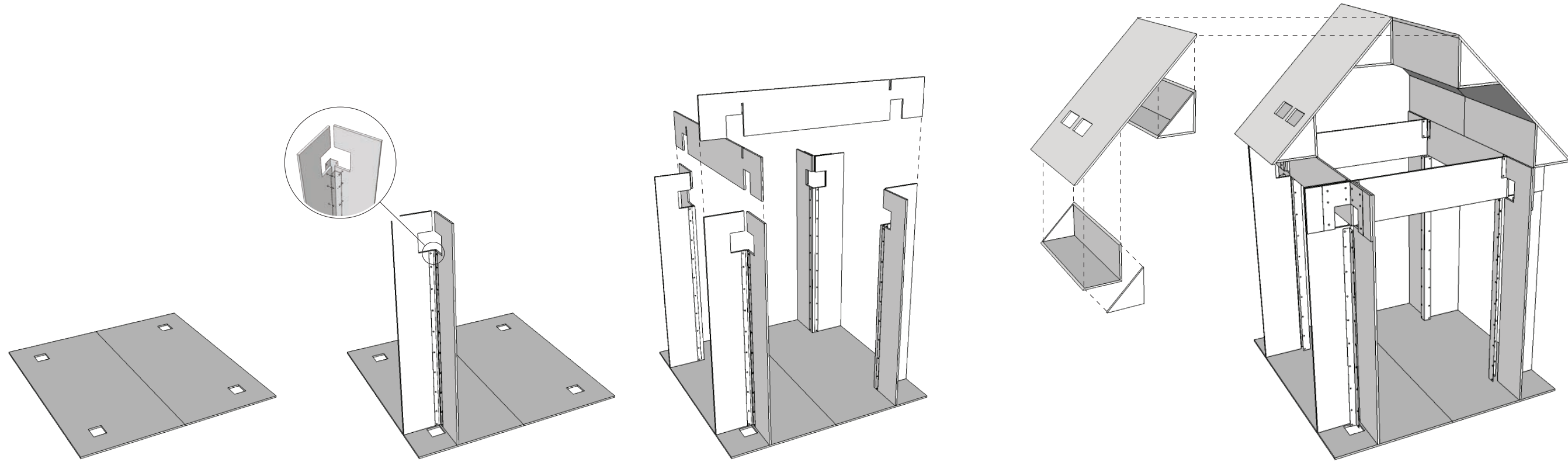

PLYWOOD

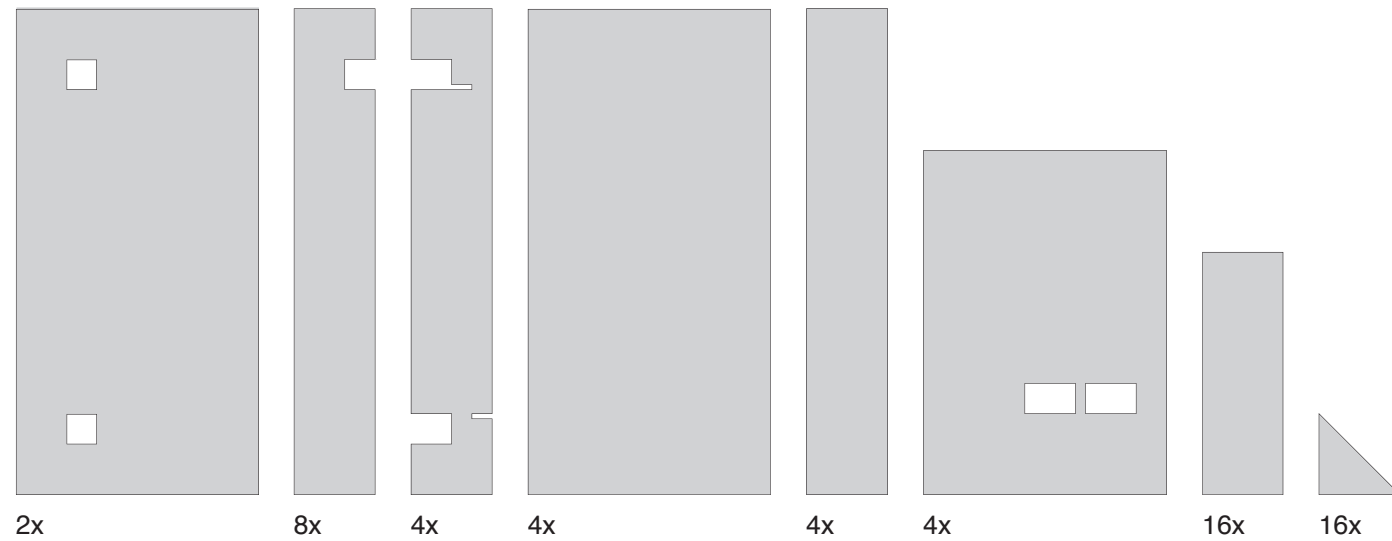

HARDWARE

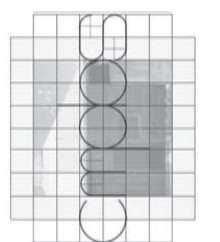
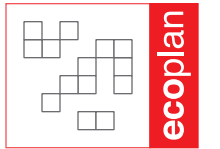
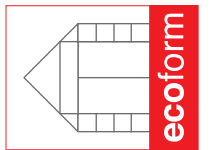
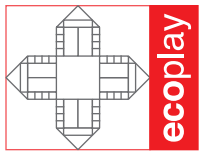
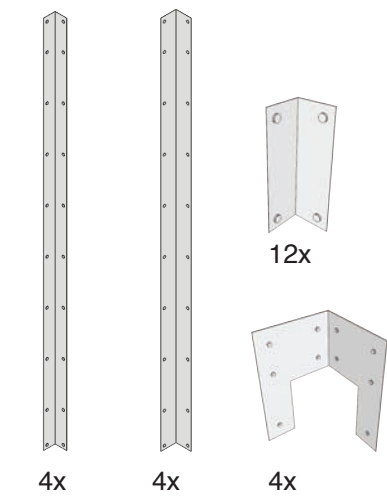

HAITI HOUSE

12 foot module

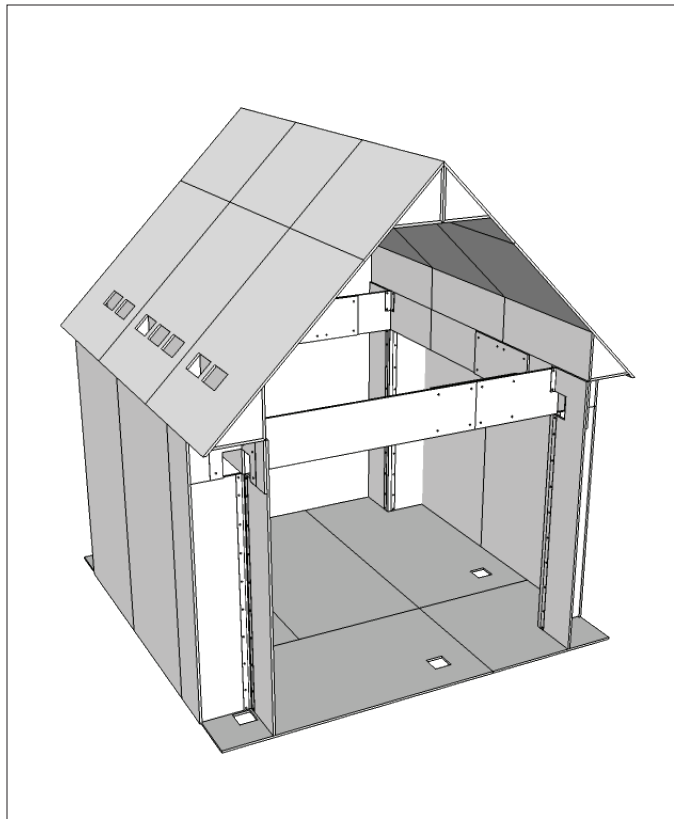
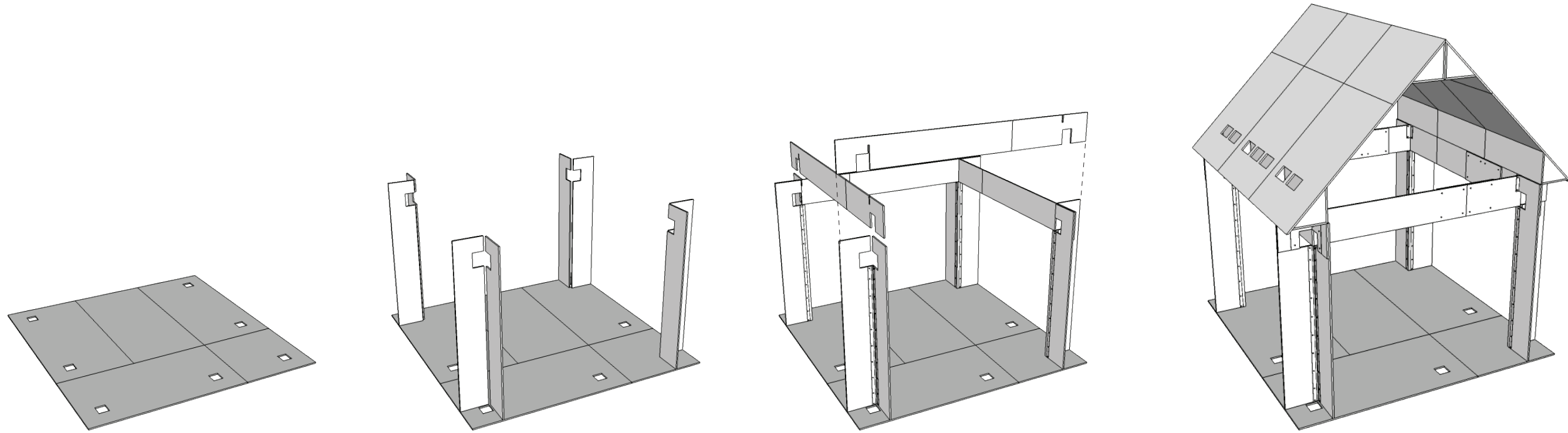

PLYWOOD

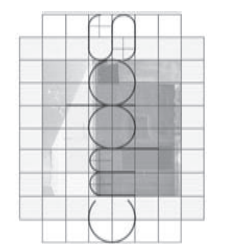
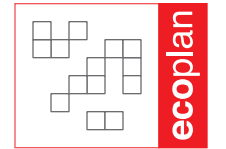
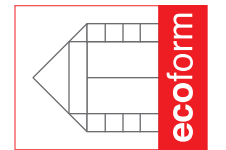
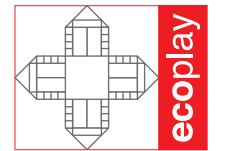
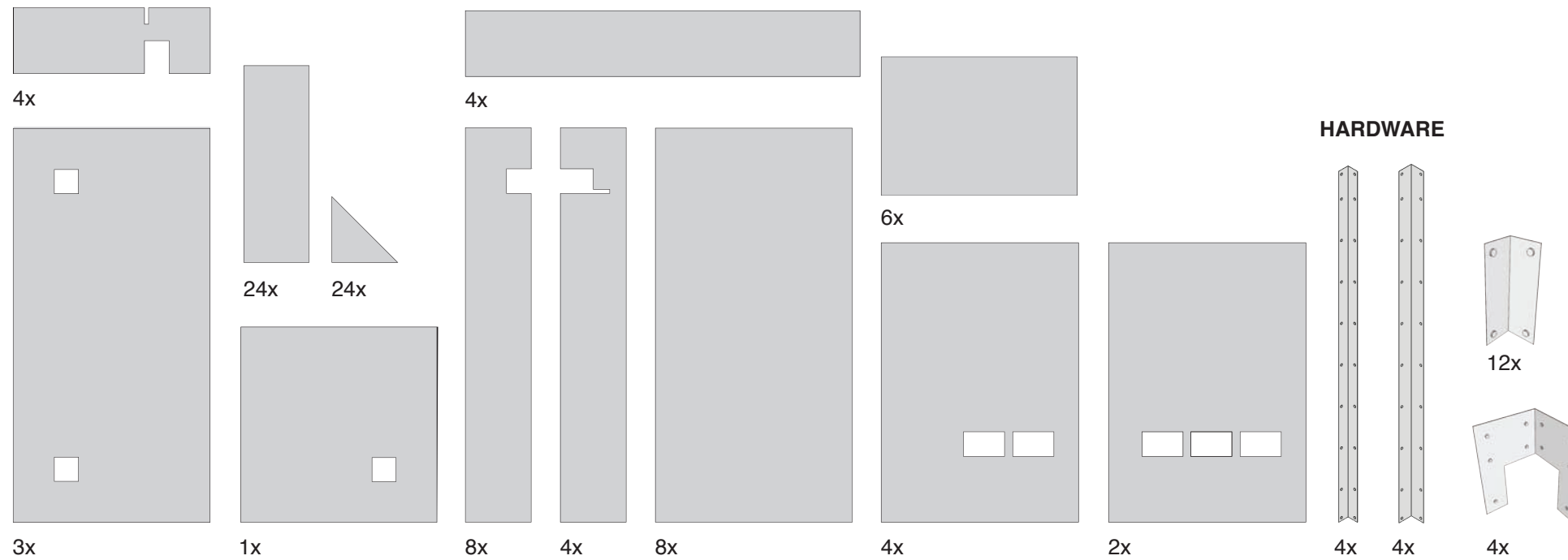

HAITI HOUSE

16 foot module

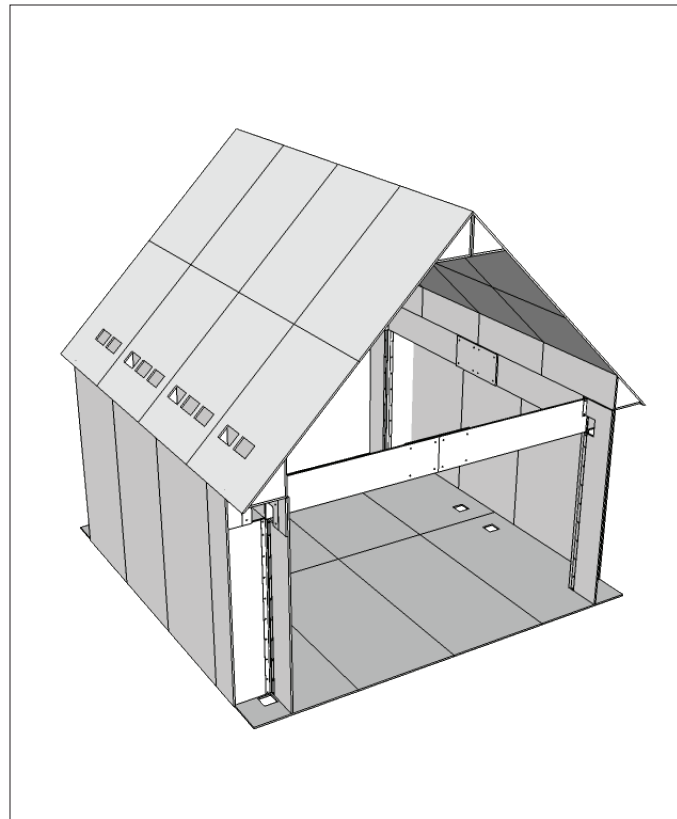
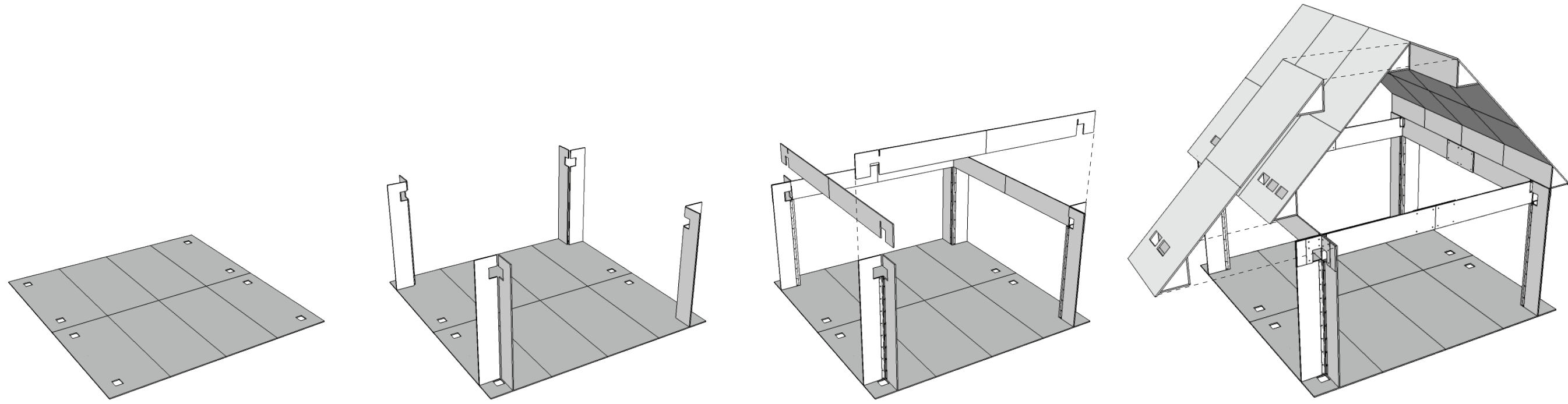

PLYWOOD

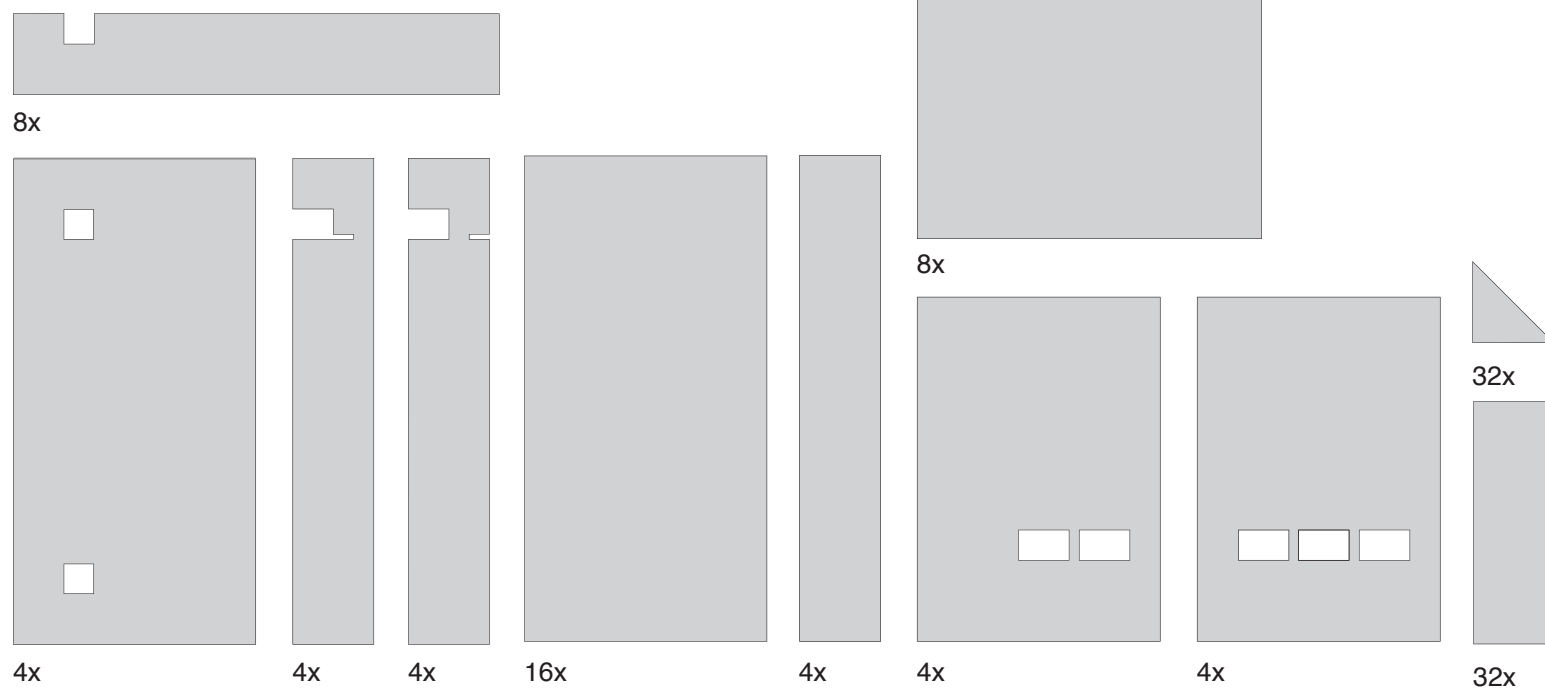

HARDWARE

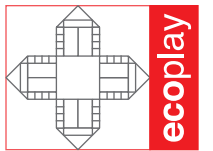
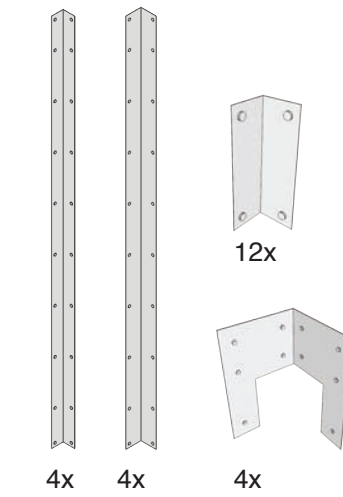

ecoplay

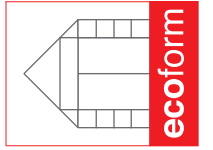

ecoform

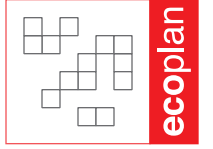

ecoplan



Island Nation Initiative

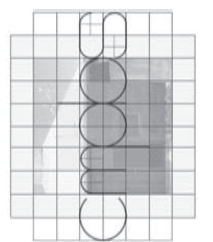

HAITI HOUSE

EVOLUTION: FROM TENT TO PERMANENT HOME

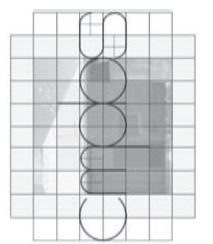
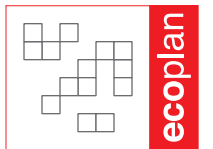
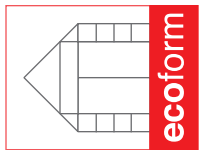
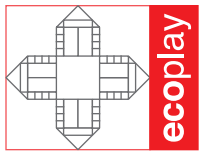
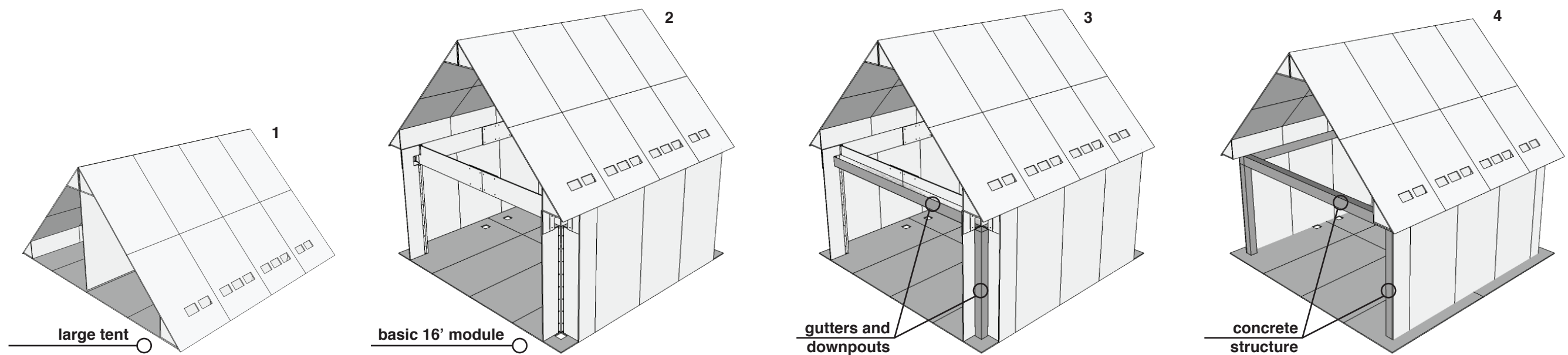
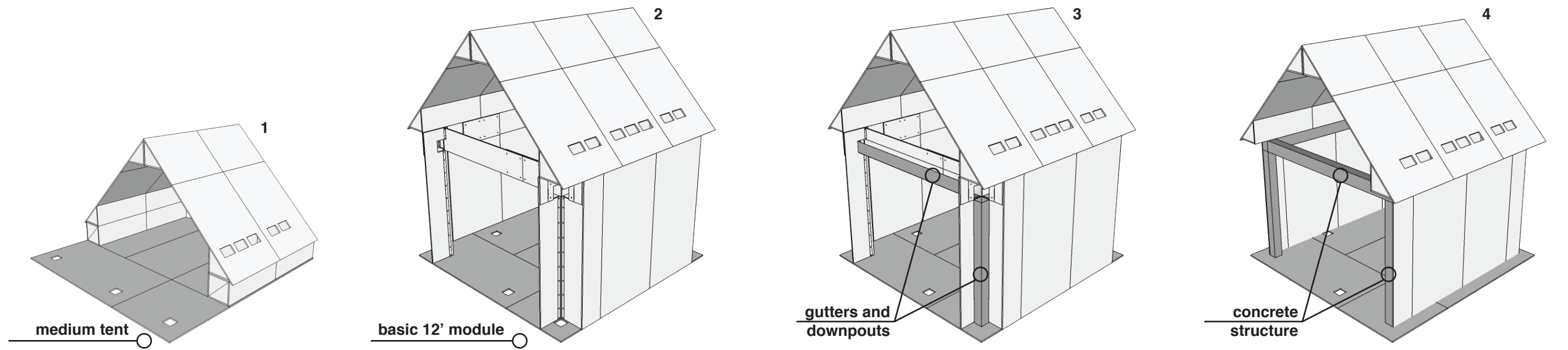
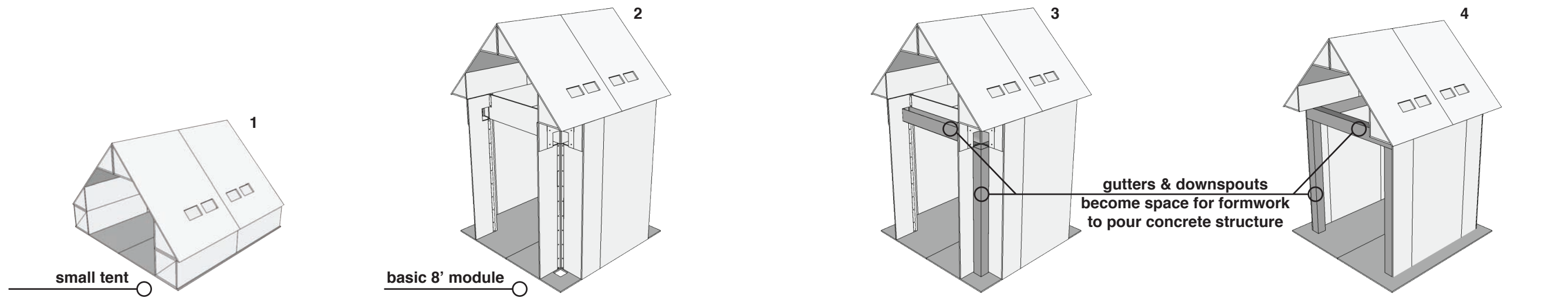

HAITI HOUSE

EVOLUTION: FROM TENT TO TWO STORY HOME

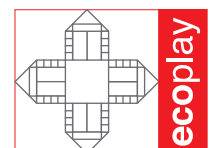
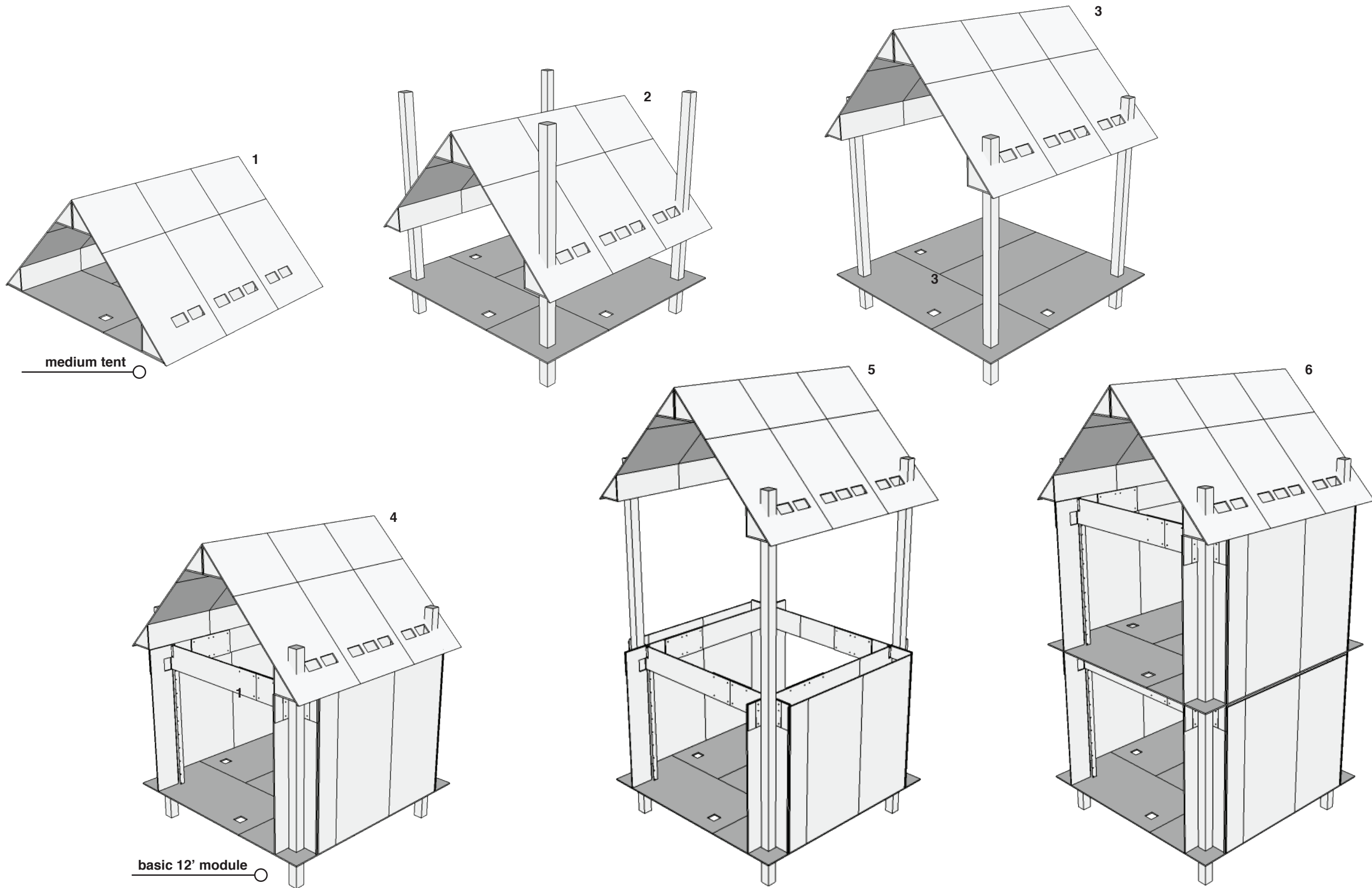

ecoplay

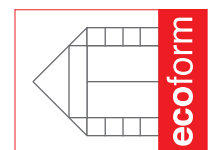

ecoform

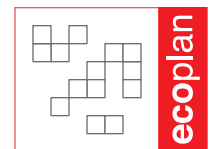

ecoplan



Island Nation Initiative

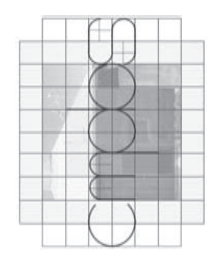

ROOF STYLES

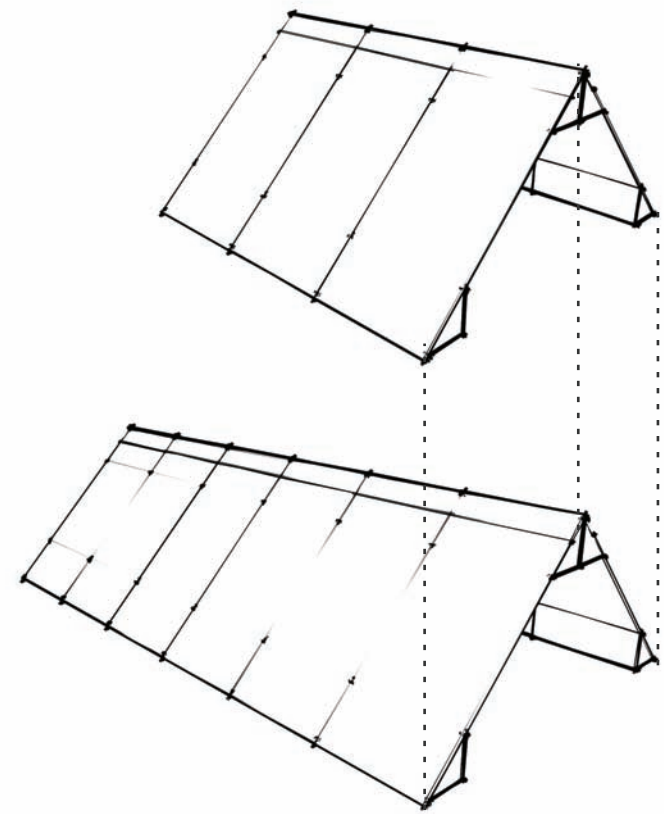

GABLE

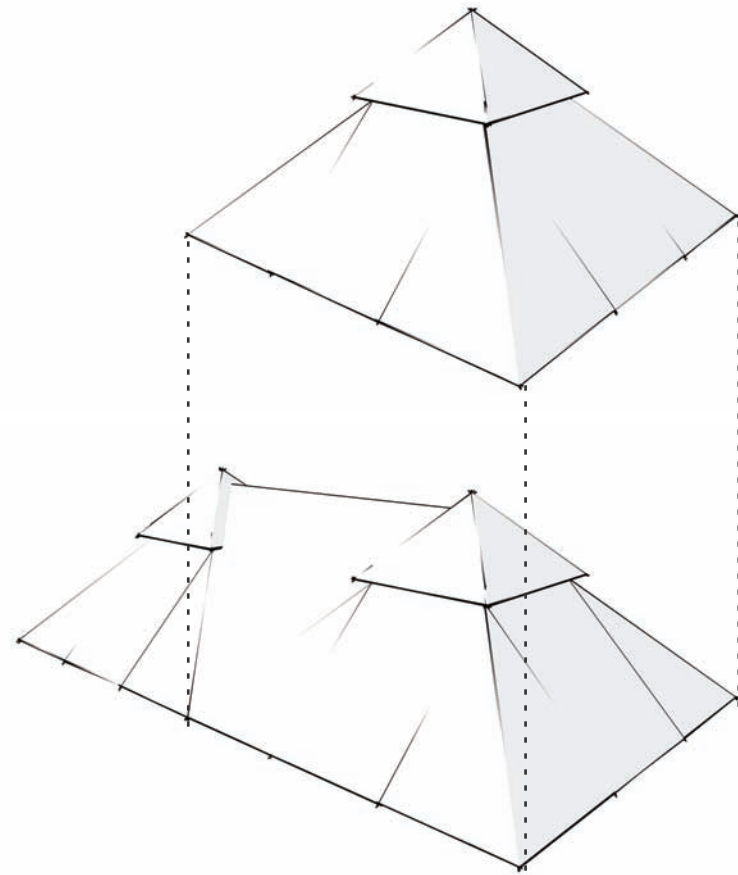

PYRAMID

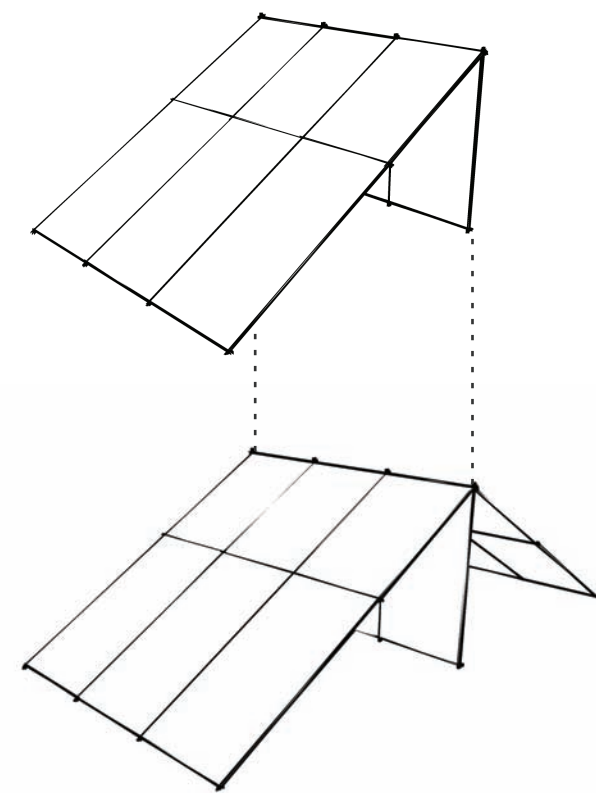

SHED

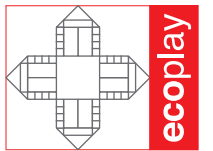

ecoplay

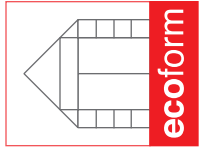

ecoform

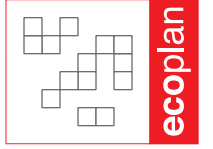

ecoplan



Island Nation Initiative

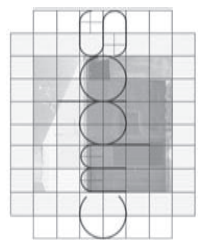

CIRCUS

HAITI HOUSE

THE NUMBERS

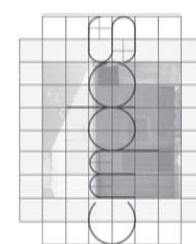
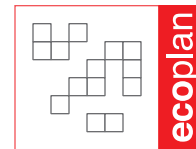
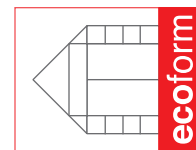
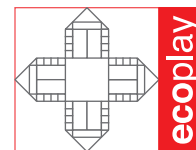
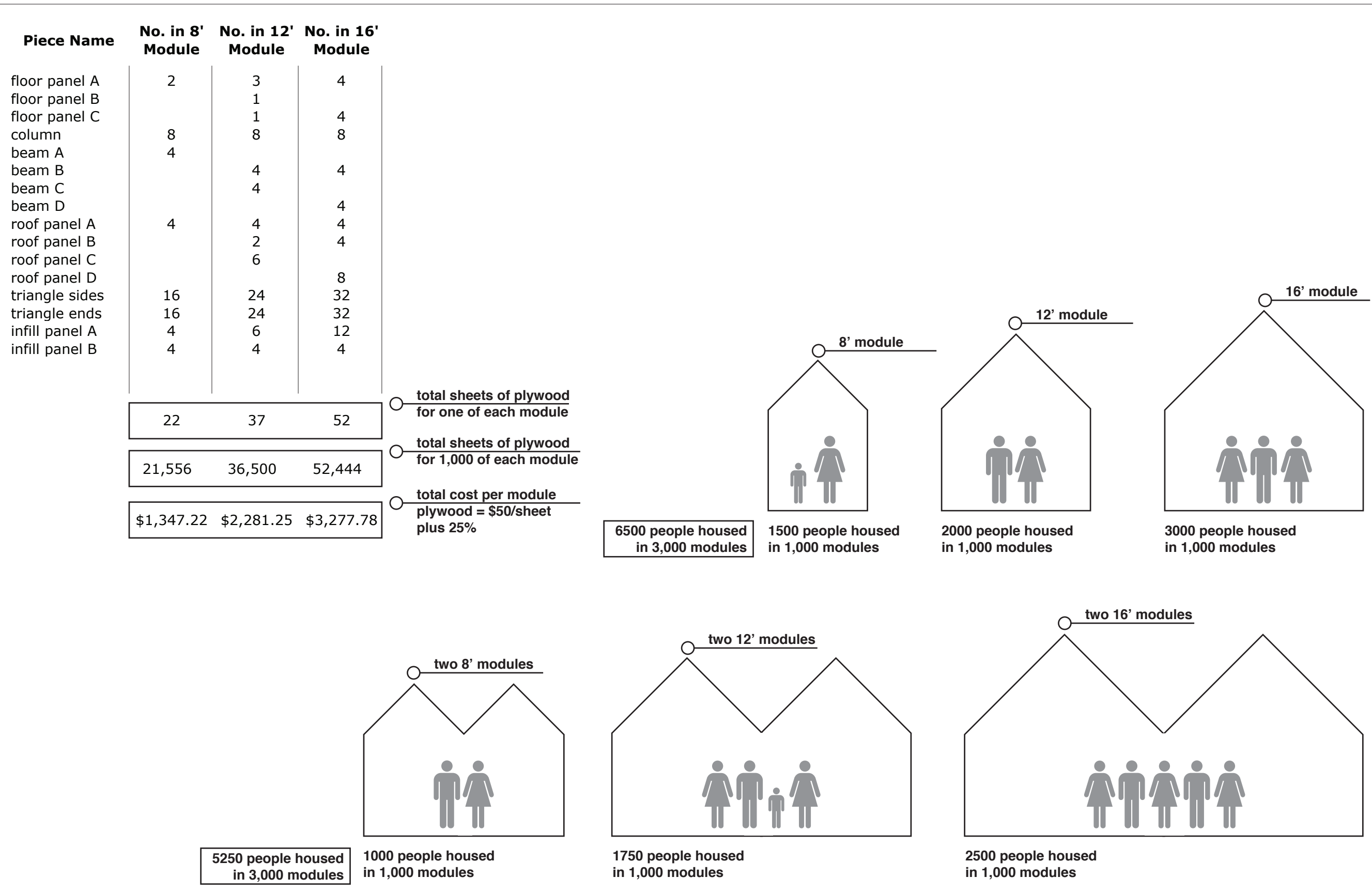

HAITI GROFORM HOUSE 12 X 12 VERSION - 03C

PERSPECTIVE OF HOUSE



NOT FOR REGULATORY
APPROVAL, PERMITTING, OR
CONSTRUCTION

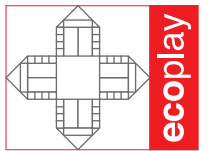

ecoplay

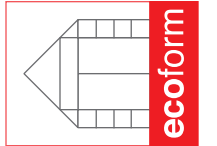

ecoform

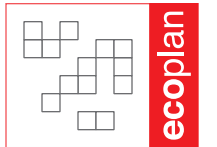

ecoplan



Island Nation Initiative

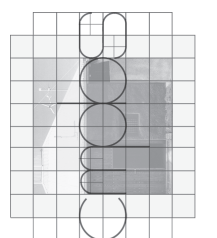

HAITI GROFORM HOUSE 12 X 12 VERSION - 03C

BEDROOM, OUTDOOR KITCHEN, BATHROOM

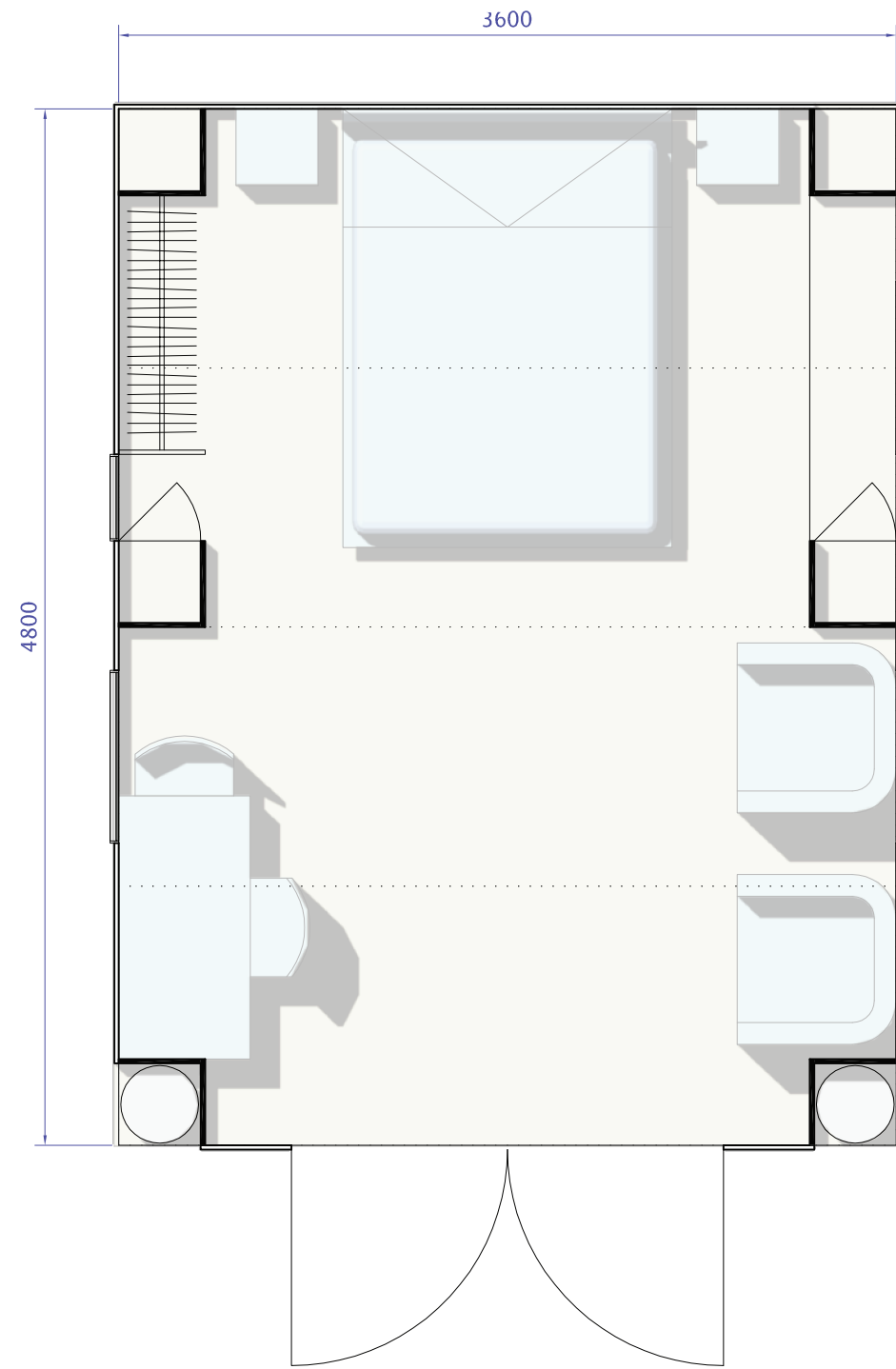

FLOORPLAN - BEDROOM/LIVING

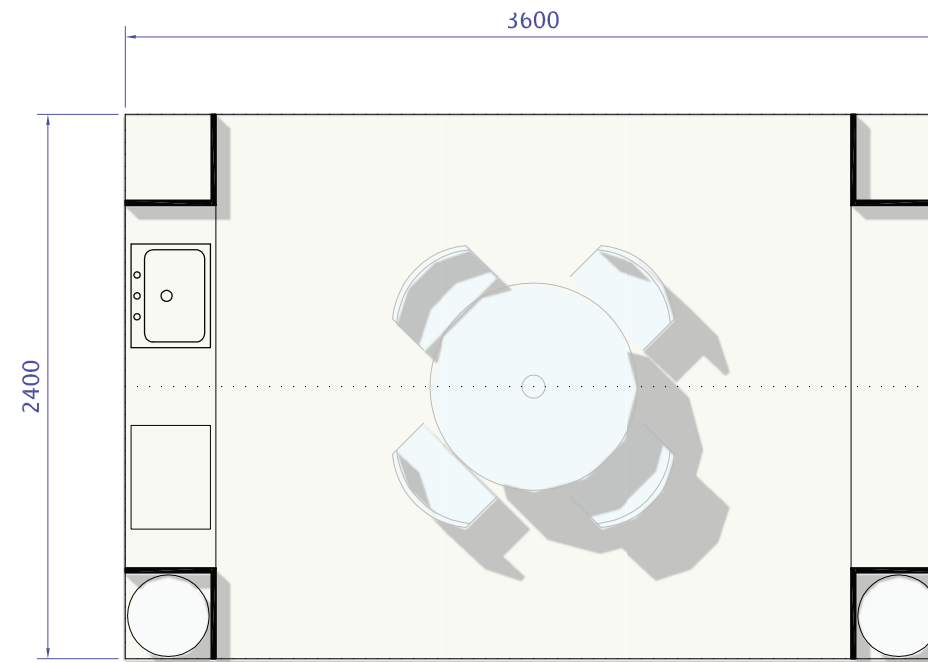

FLOORPLAN - OUTDOOR KITCHEN

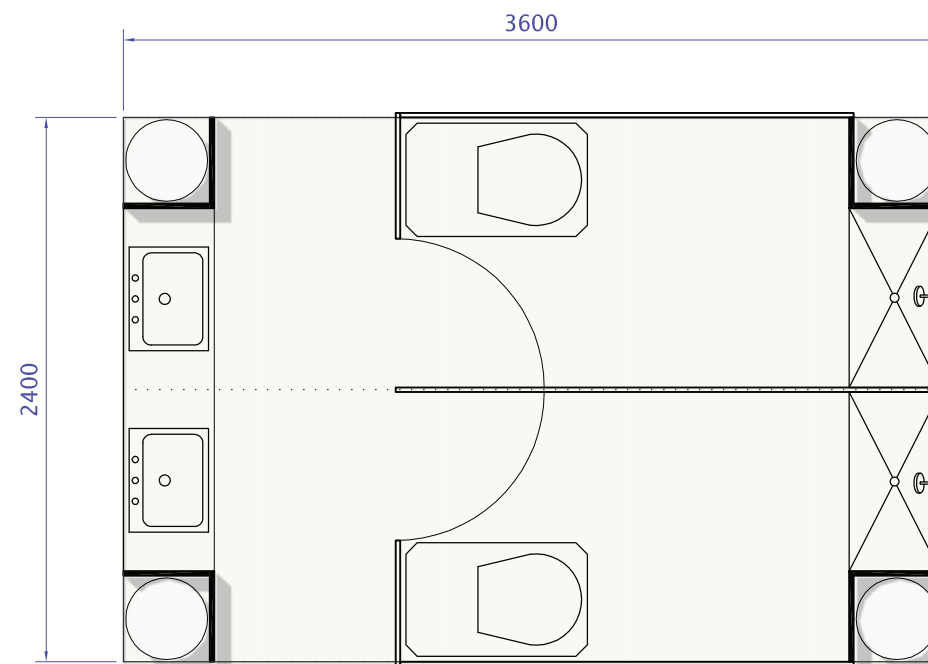

FLOORPLAN - BATHROOMS

NOT FOR REGULATORY
APPROVAL, PERMITTING, OR
CONSTRUCTION

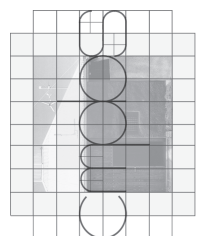
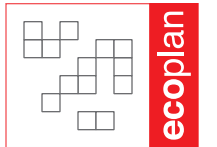
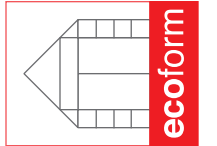
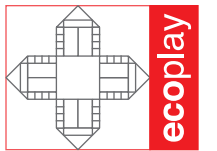

HAITI GROFORM HOUSE 12 X 12 VERSION - 03C

FLOOR PLAN

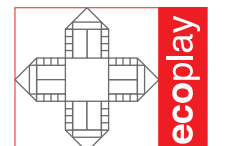
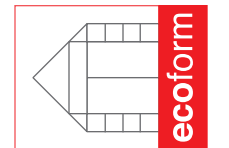
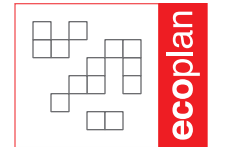
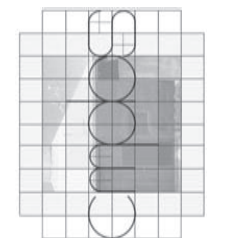
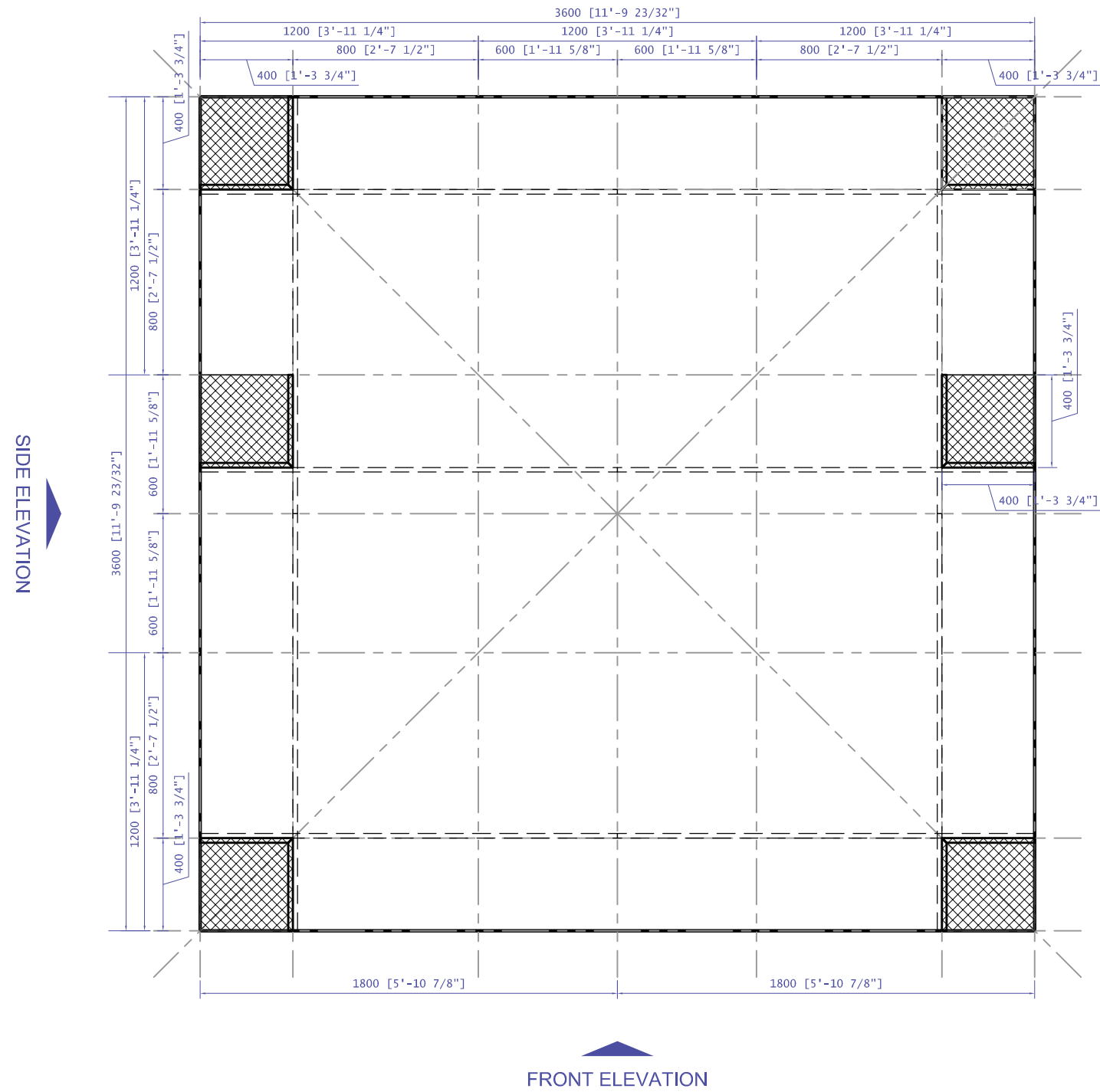

**NOT FOR REGULATORY
APPROVAL, PERMITTING, OR
CONSTRUCTION**

HAITI GROFORM HOUSE 12 X 12 VERSION - 03C

ROOF / FRAMING PLAN

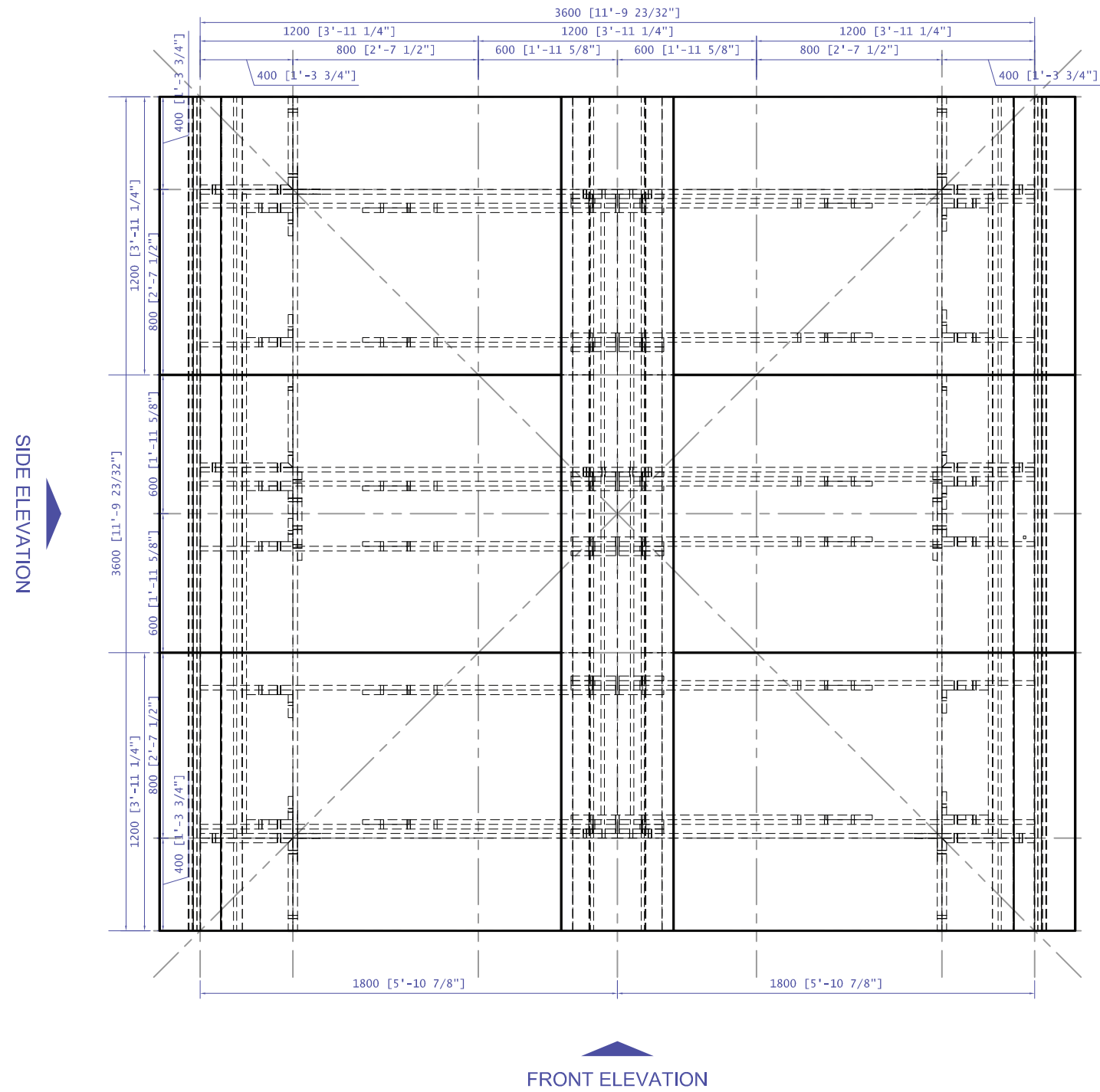

NOT FOR REGULATORY
APPROVAL, PERMITTING, OR
CONSTRUCTION

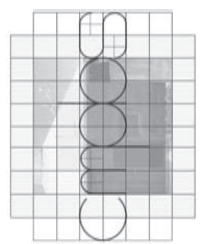
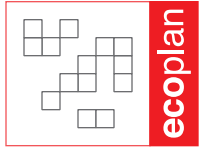
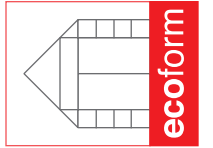
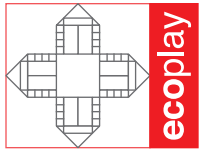

HAITI GROFORM HOUSE 12 X 12 VERSION - 03C

FRONT ELEVATION

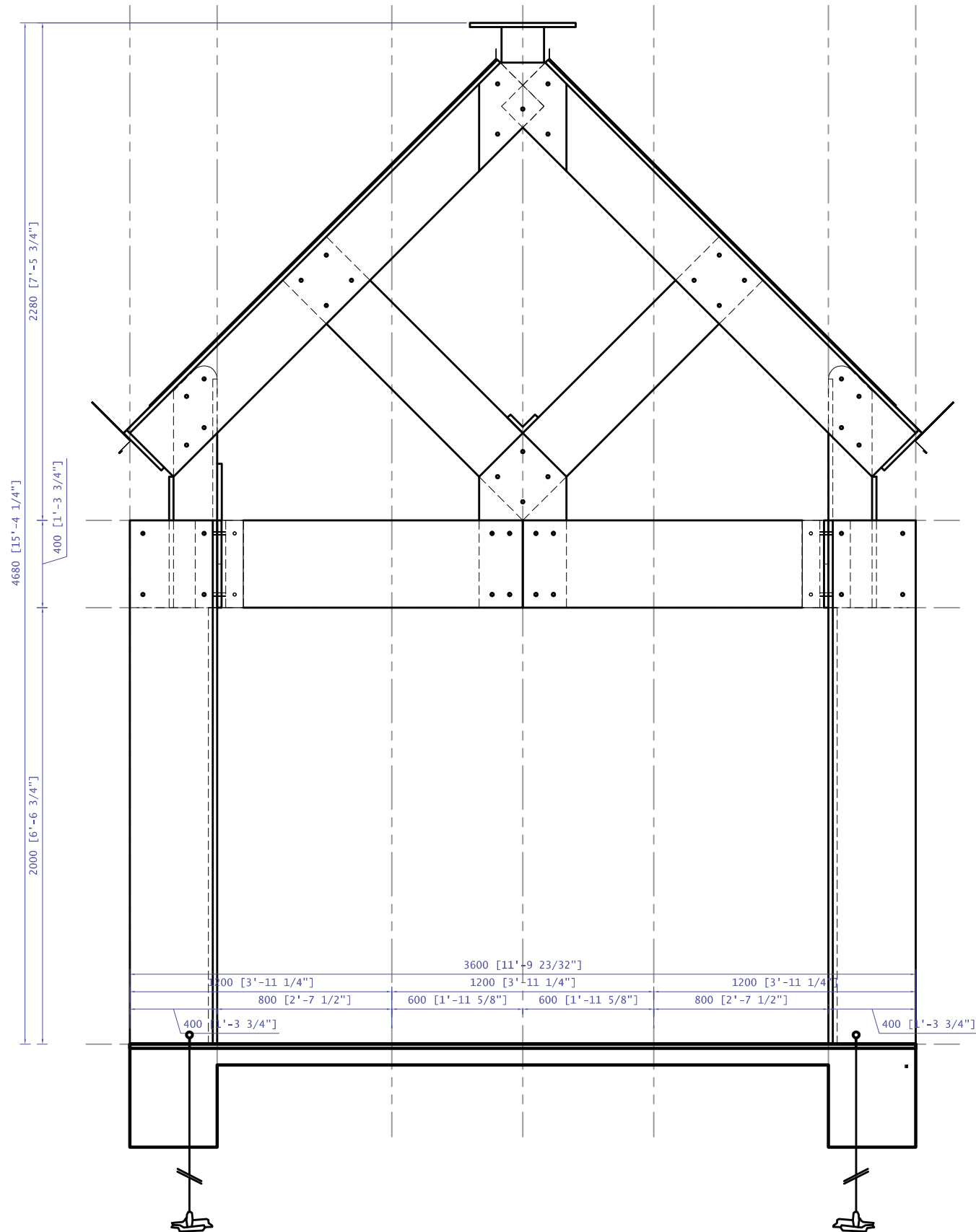

NOT FOR REGULATORY
APPROVAL, PERMITTING, OR
CONSTRUCTION

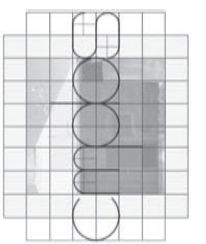
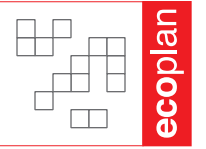
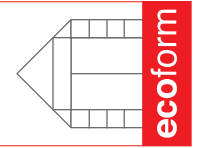
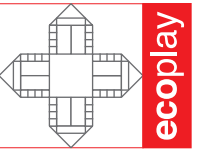

HAITI GROFORM HOUSE 12 X 12 VERSION - 03C

SIDE ELEVATION

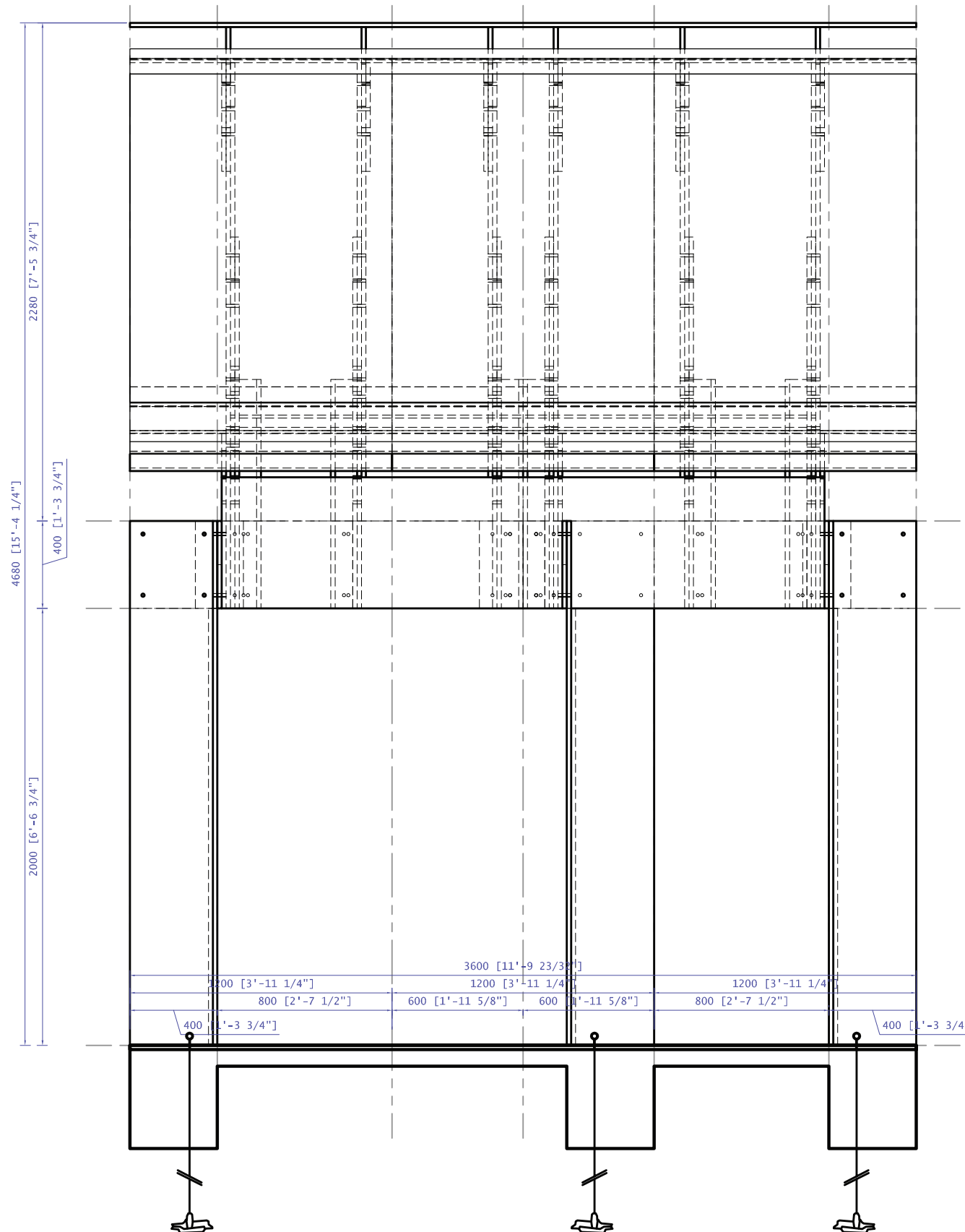

NOT FOR REGULATORY
APPROVAL, PERMITTING, OR
CONSTRUCTION

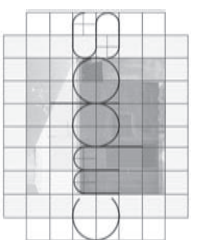
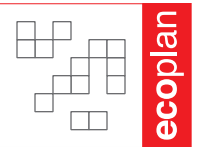
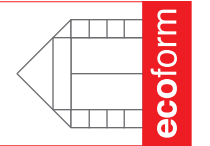
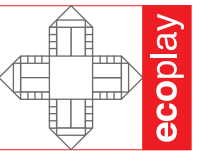

HAITI GROFORM HOUSE 12 X 12 VERSION - 03C

PLYWOOD - BASE ELEMENTS

3/4" PLYWOOD (8)

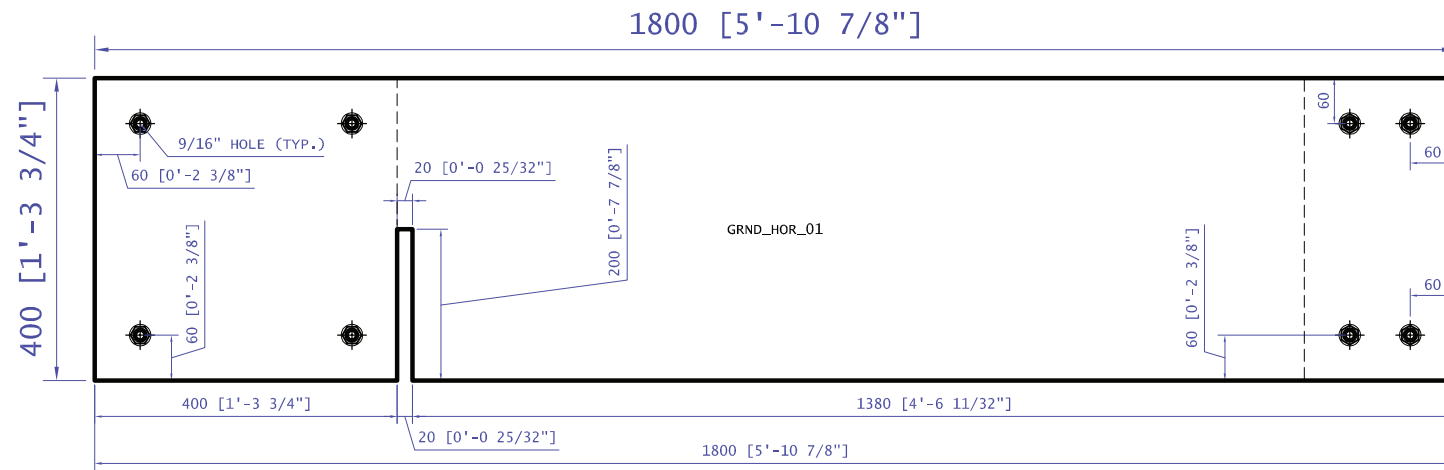

3/4" PLYWOOD (2)

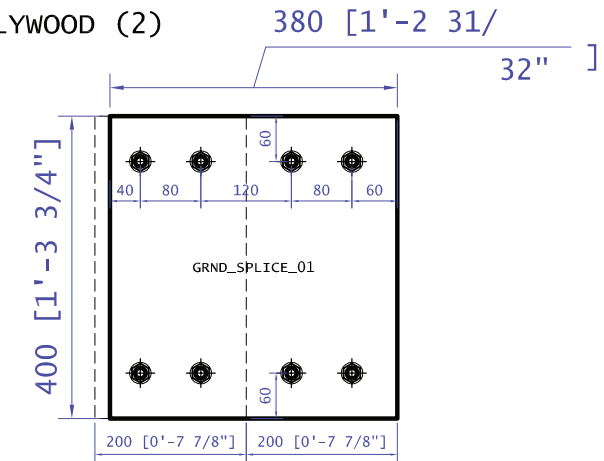

3/4" PLYWOOD (2)

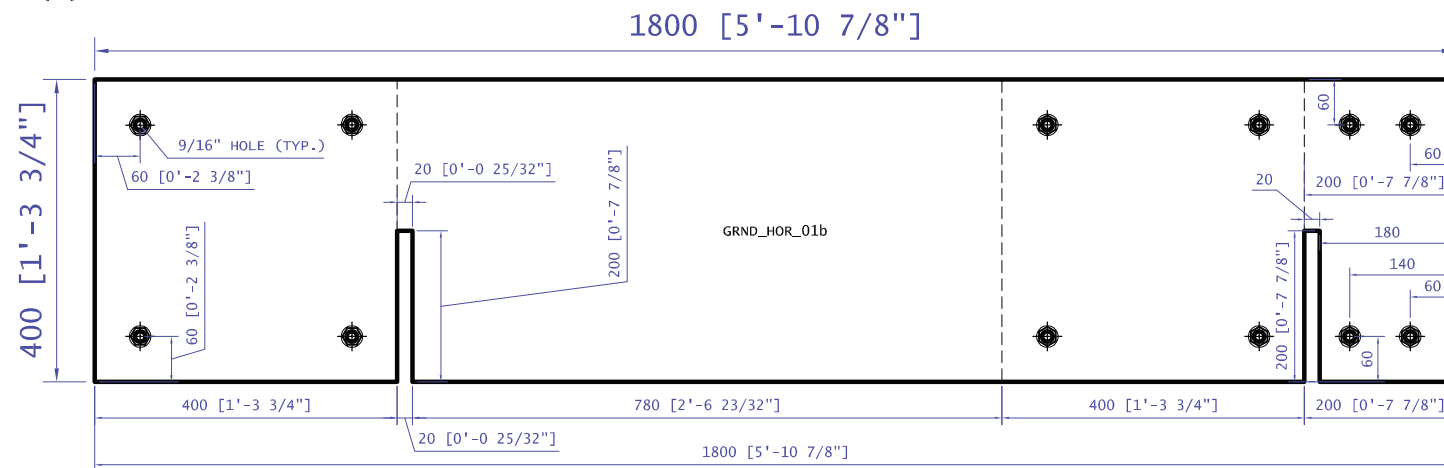

3/4" PLYWOOD (6) [MIRROR HOLES FOR 3 PAIRS]

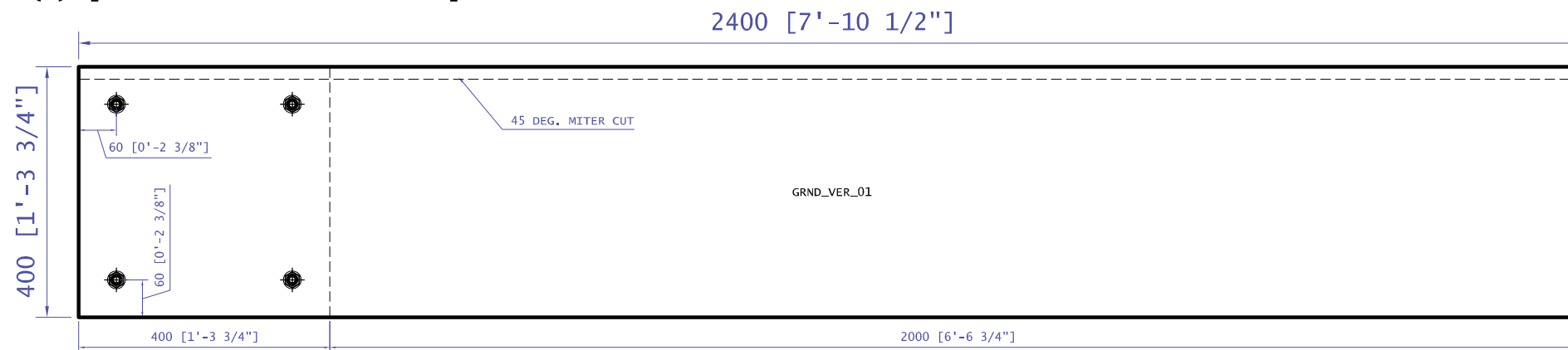

NOT FOR REGULATORY
APPROVAL, PERMITTING, OR
CONSTRUCTION

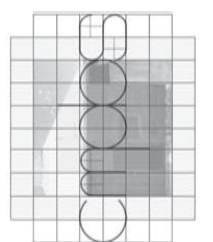
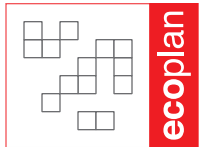
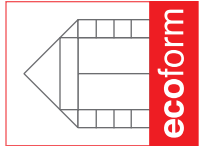
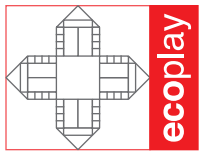

HAITI GROFORM HOUSE 12 X 12 VERSION - 03C

PLYWOOD - TENT / ROOF ELEMENTS (1 OF 3)

3/4" PLYWOOD (12)

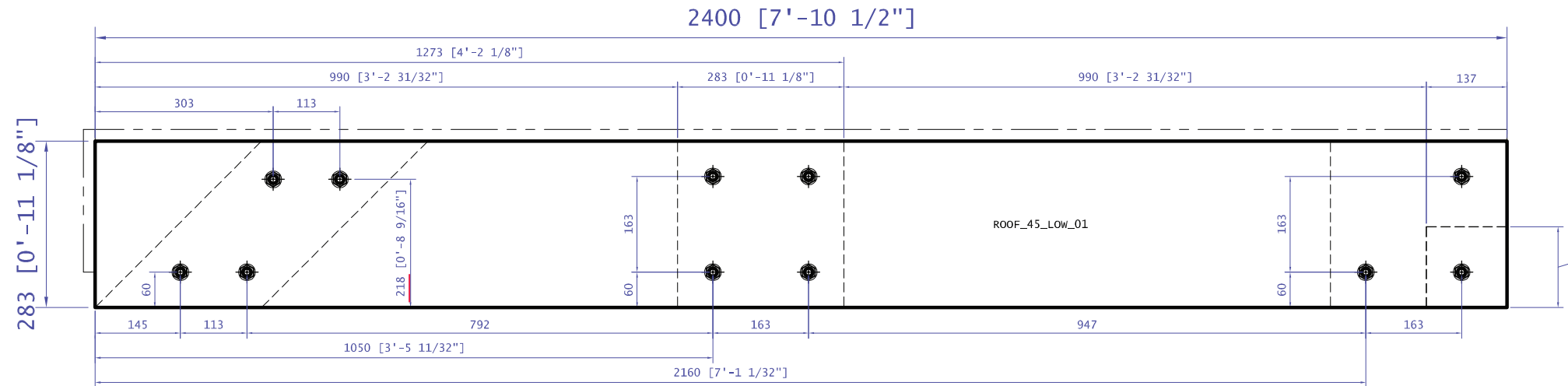

3/4" PLYWOOD (12)

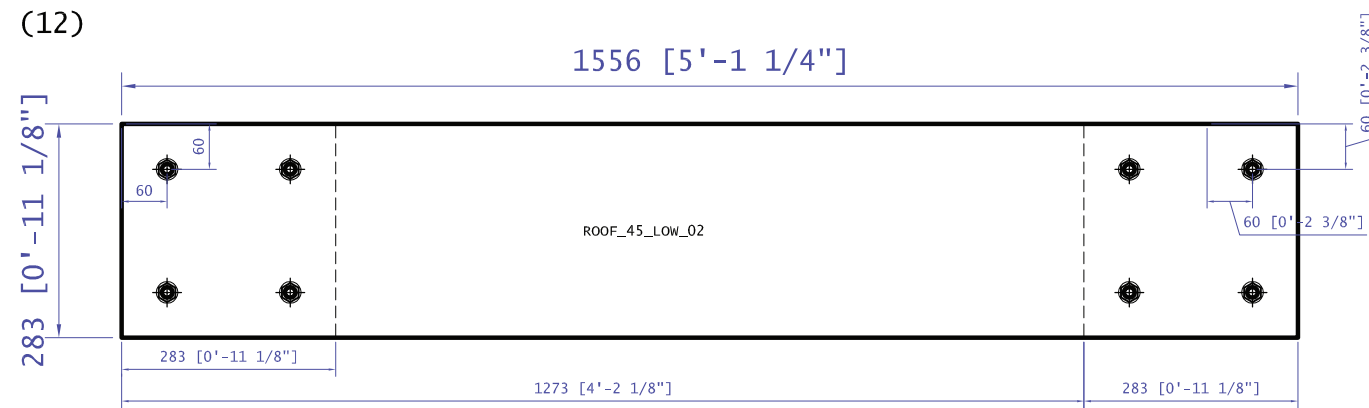

3/4" PLYWOOD (4)

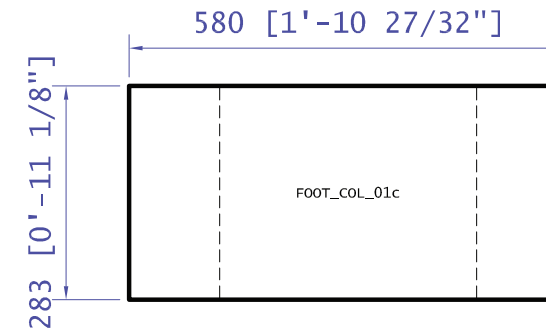

3/4" PLYWOOD (2)

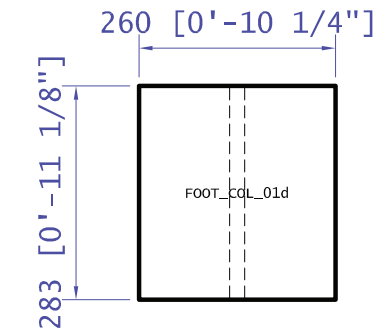

3/4" PLYWOOD (12)

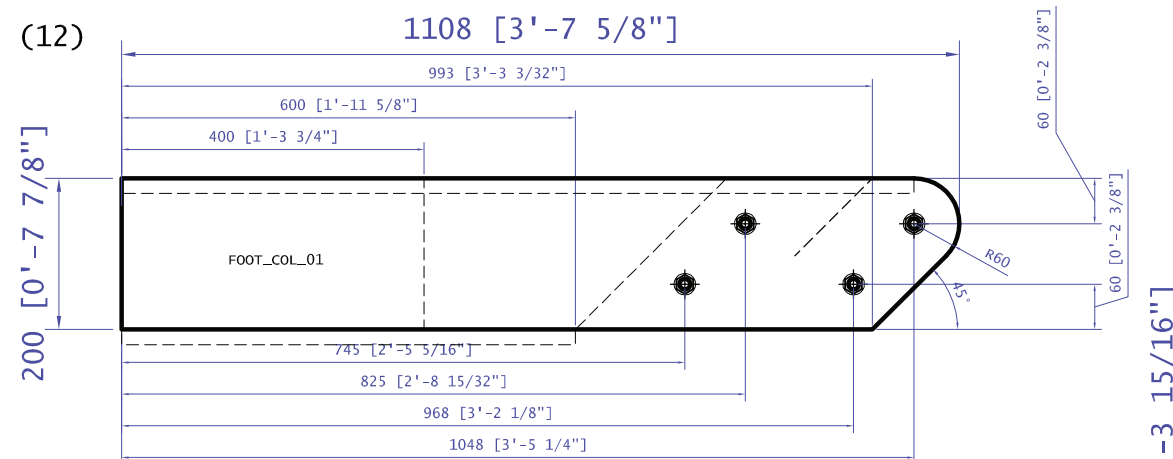

3/4" PLYWOOD (3)

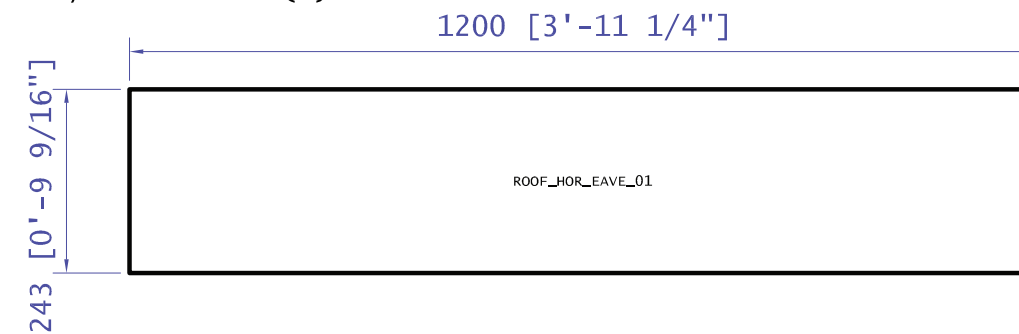

3/4" PLYWOOD (12)

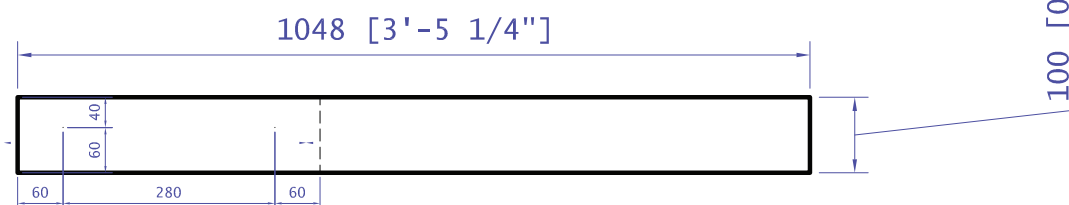

NOT FOR REGULATORY
APPROVAL, PERMITTING, OR
CONSTRUCTION

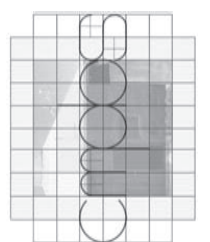
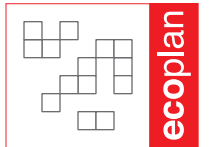
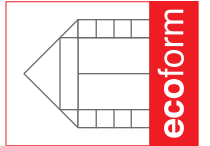
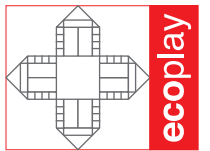

HAITI GROFORM HOUSE 12 X 12 VERSION - 03C

PLYWOOD - TENT / ROOF ELEMENTS (2 OF 3)

3/4" PLYWOOD (2)

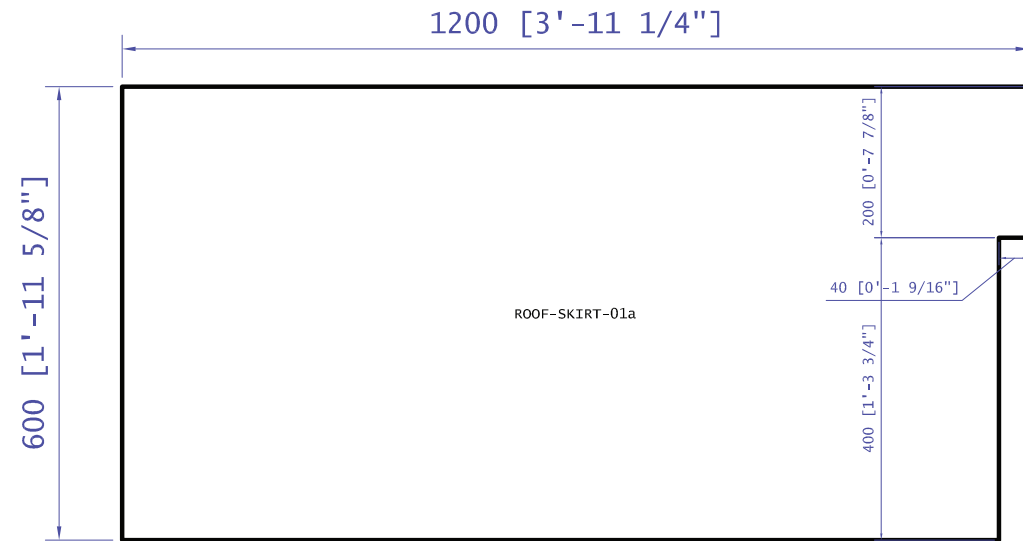

3/4" PLYWOOD (2)

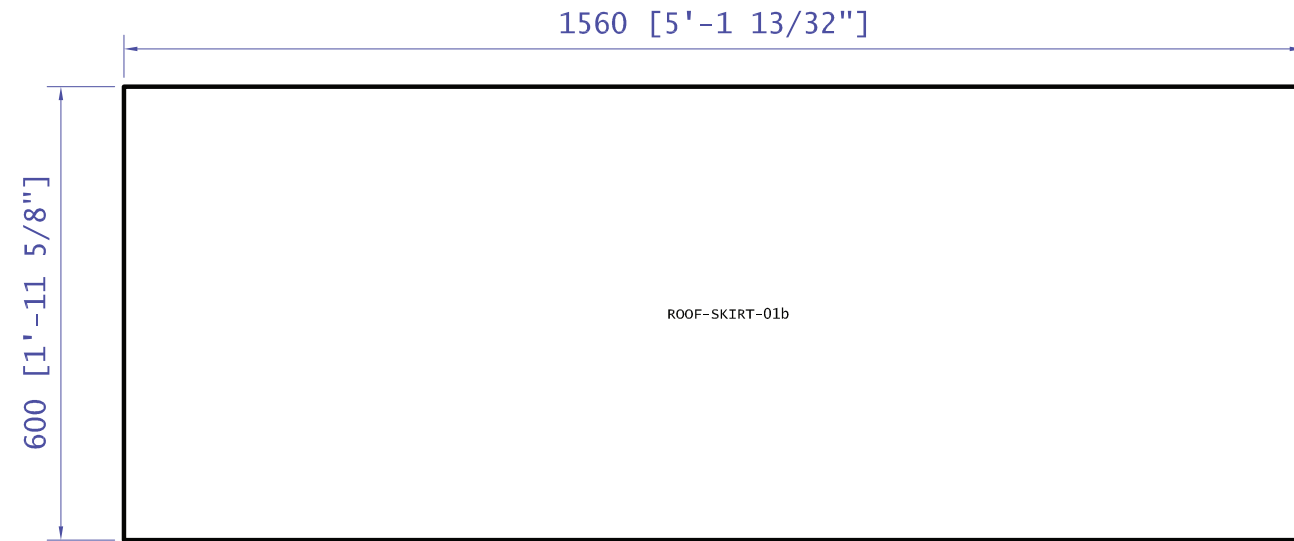

3/4" PLYWOOD (3)

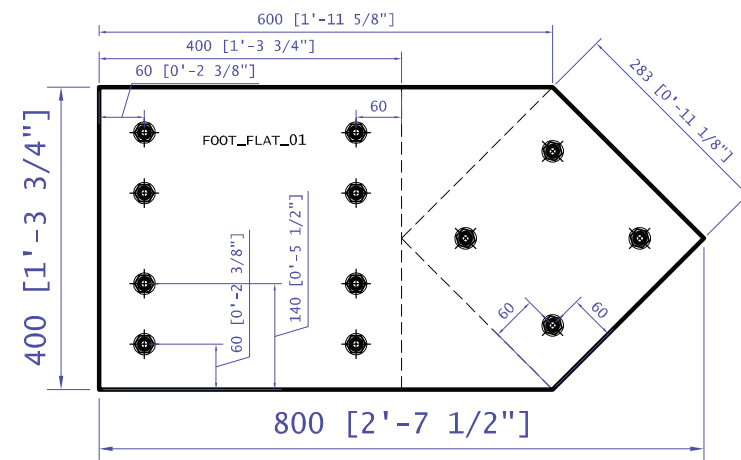

3/4" PLYWOOD (6)

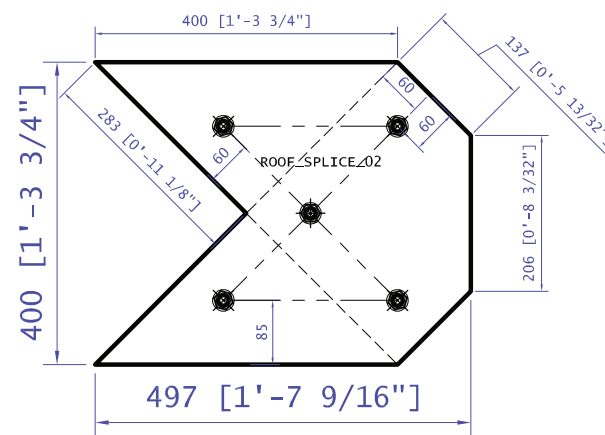

3/4" PLYWOOD (6)

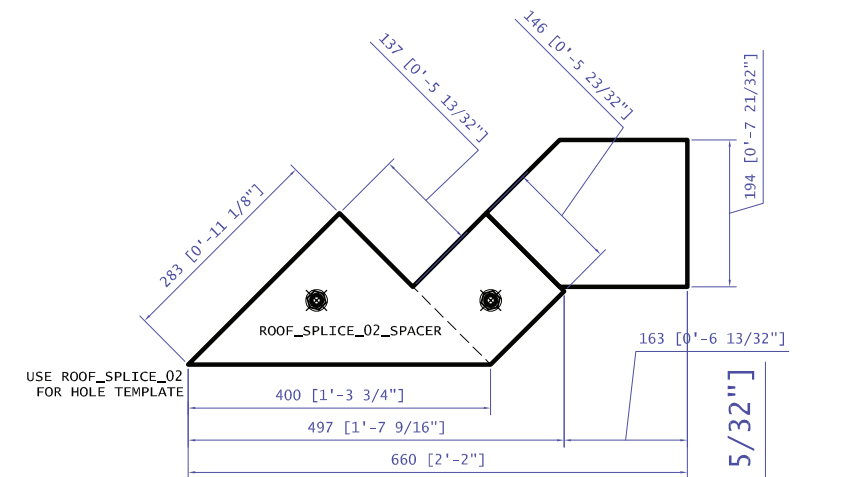

3/4" PLYWOOD (1)

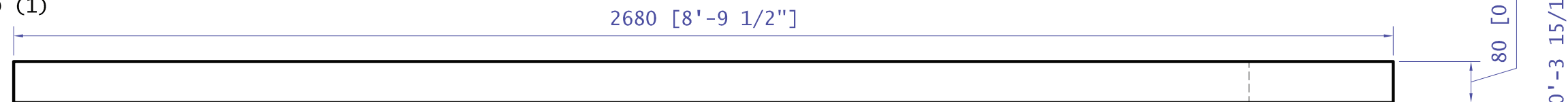

3/4" PLYWOOD (1)

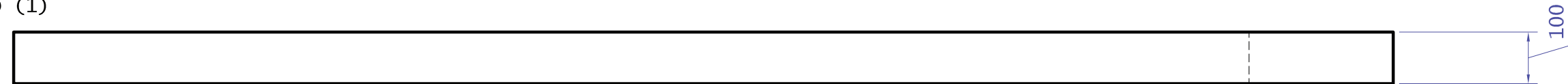

NOT FOR REGULATORY
APPROVAL, PERMITTING, OR
CONSTRUCTION

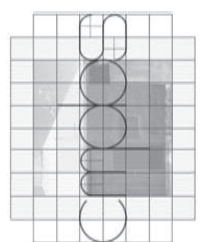
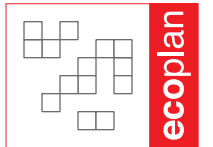
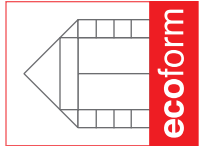
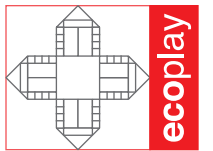

HAITI GROFORM HOUSE 12 X 12 VERSION - 03C

PLYWOOD - TENT / ROOF ELEMENTS (3 OF 3)

3/4" PLYWOOD (6)



NOT FOR REGULATORY
APPROVAL, PERMITTING, OR
CONSTRUCTION

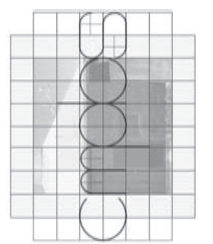
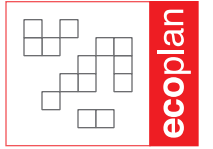
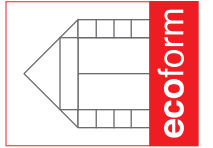
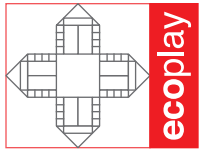

HAITI GROFORM HOUSE 12 X 12 VERSION - 03C

PLYWOOD - CUT SCHEDULE

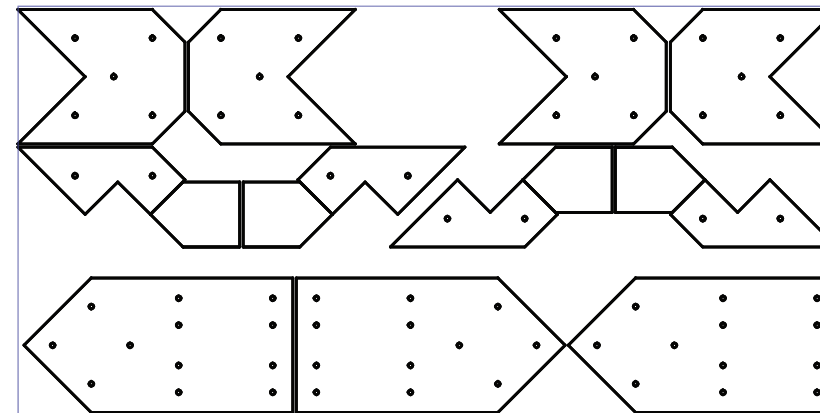
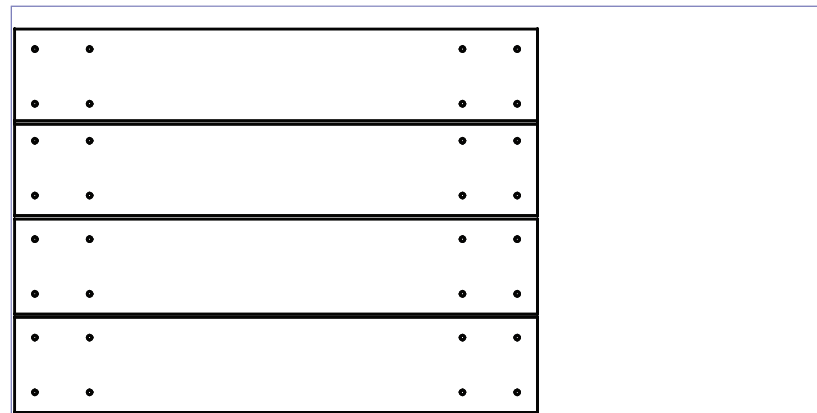
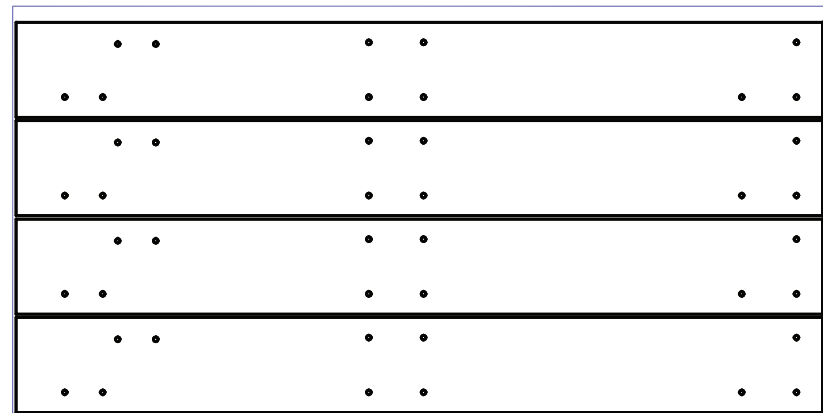
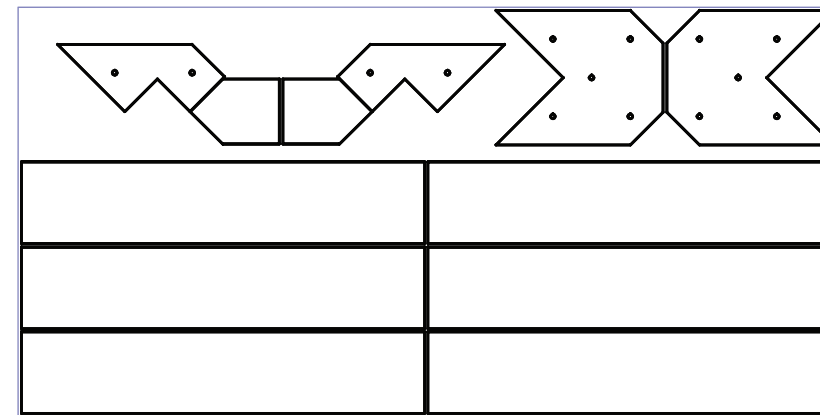
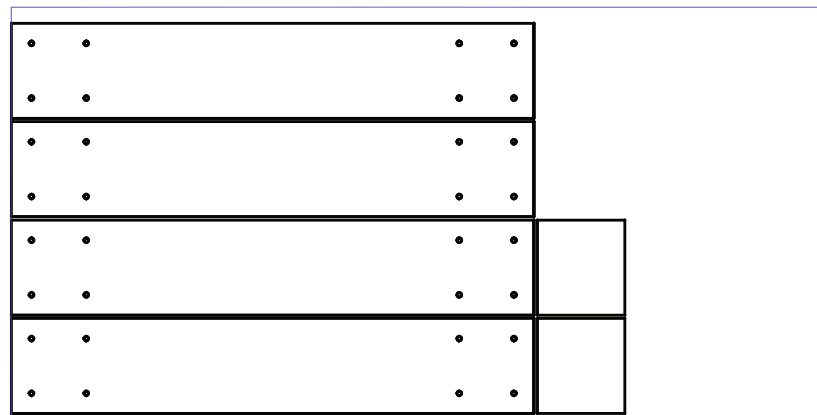
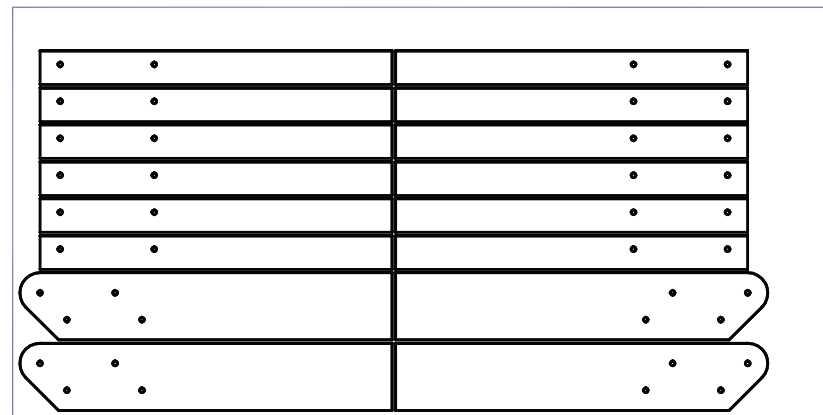
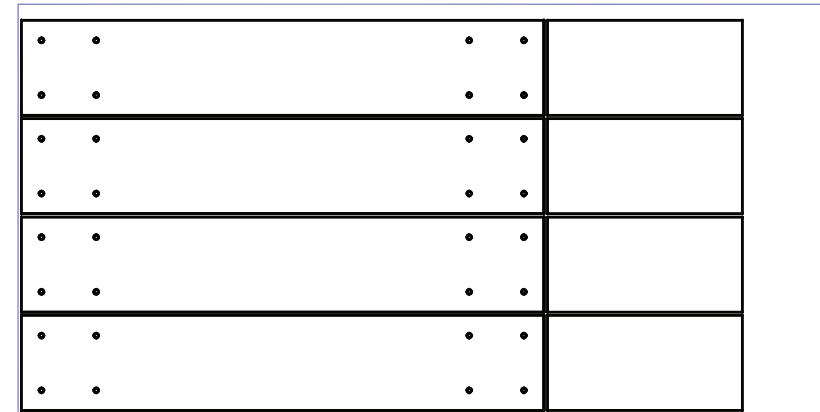
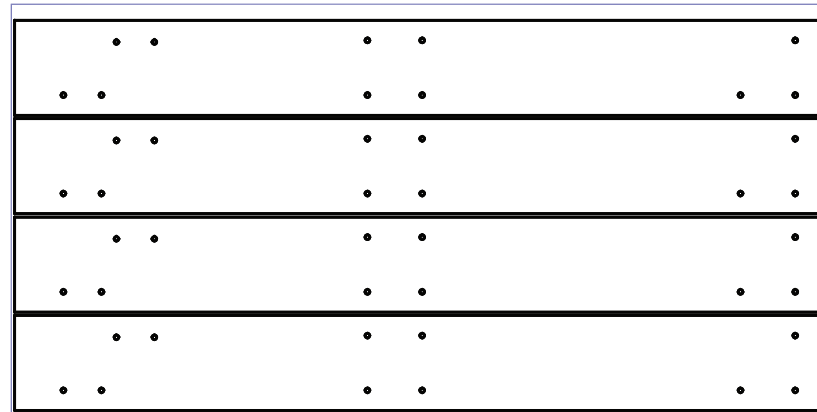
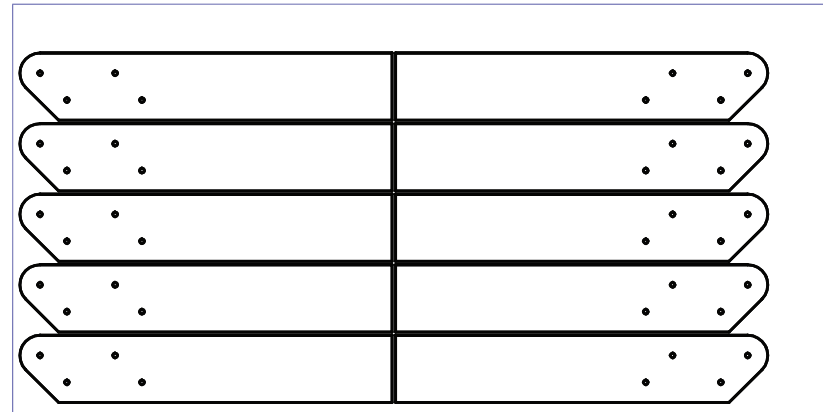

NOT FOR REGULATORY
APPROVAL, PERMITTING, OR
CONSTRUCTION

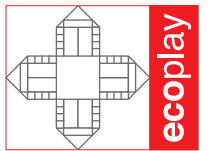

ecoplay

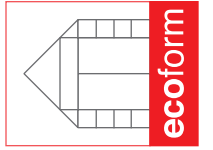

ecoform

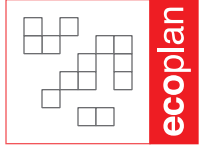

ecoplan

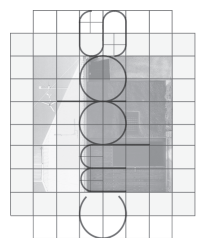

INFRASTRUCTURE

POP-OUT FURNITURE

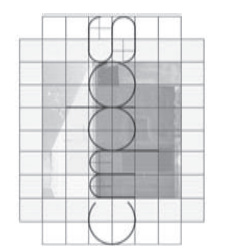
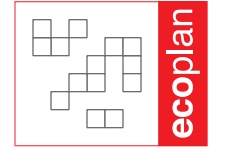
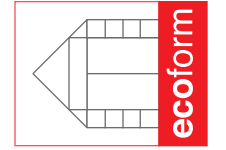
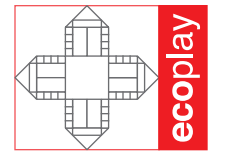
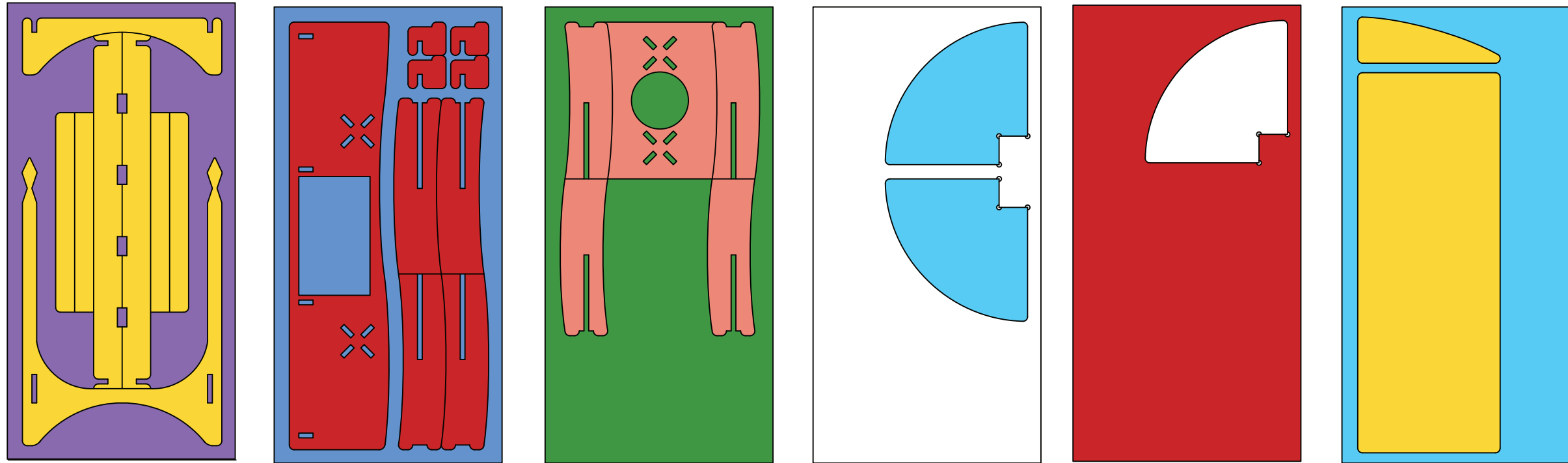
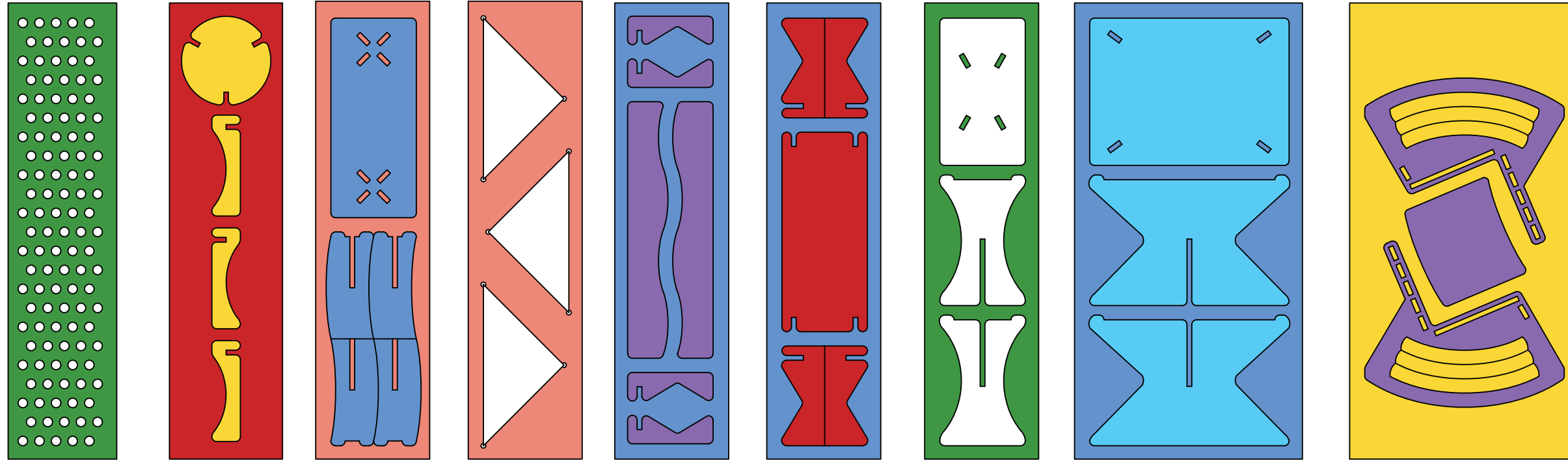

INFRASTRUCTURE

POP-OUT FURNITURE INSTALLATION

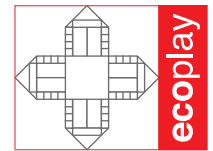
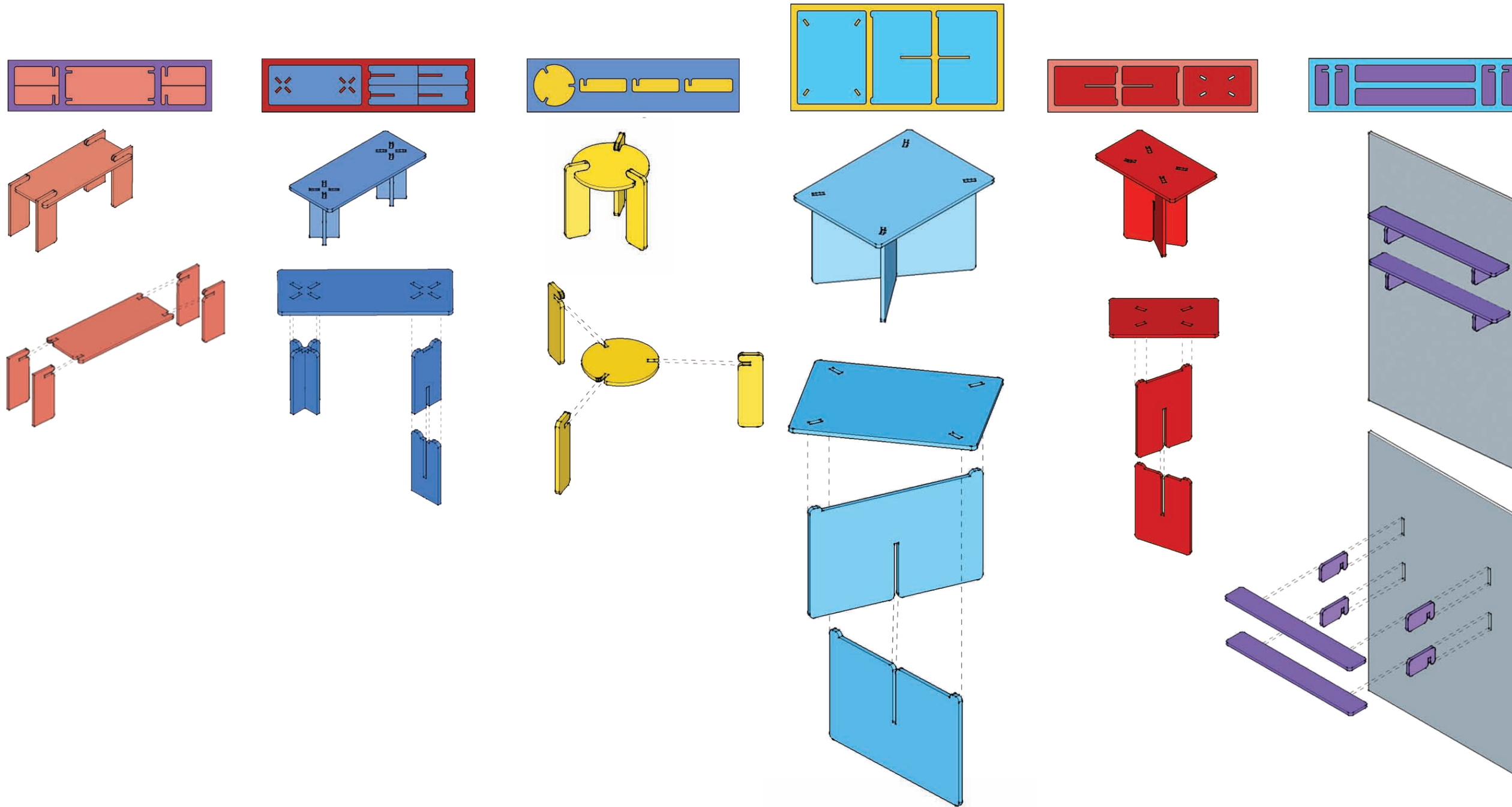

ecoplay

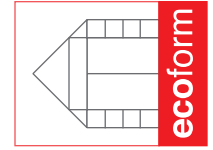

ecoform



ecoplan



Island Nation Initiative

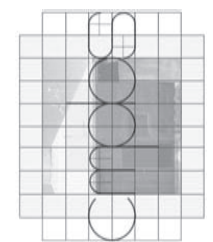

EVOLUTION OF FORM

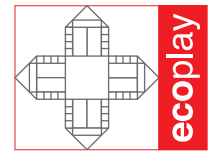
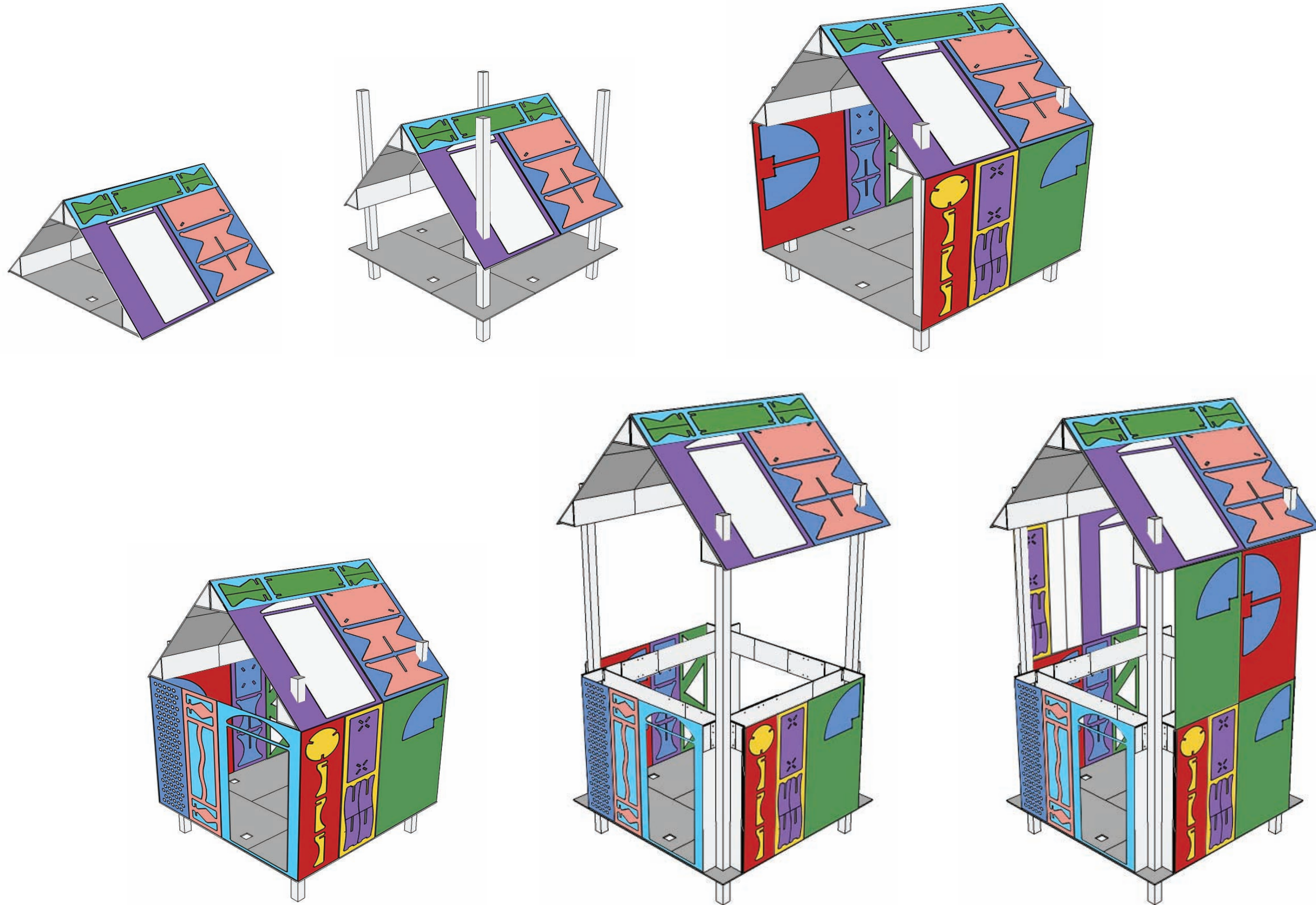

ecoplay

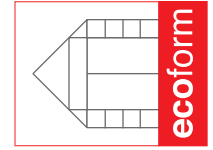

ecoform



ecoplan



Island Nation Initiative

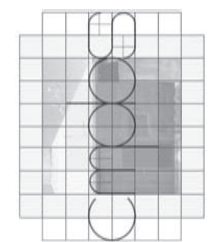

Opening and Closing the Home

REGULATES AIR FLOW, ALLOWS FOR SECURITY AT NIGHT AND INCLEMENT WEATHER

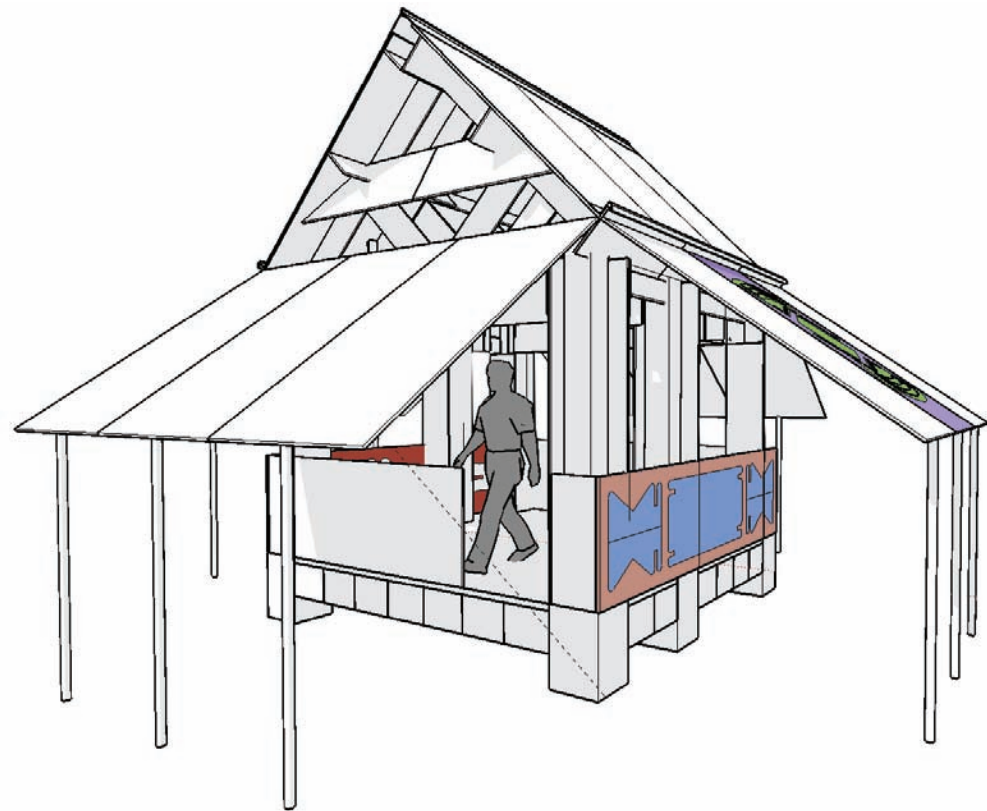

ALL PANELS OPEN

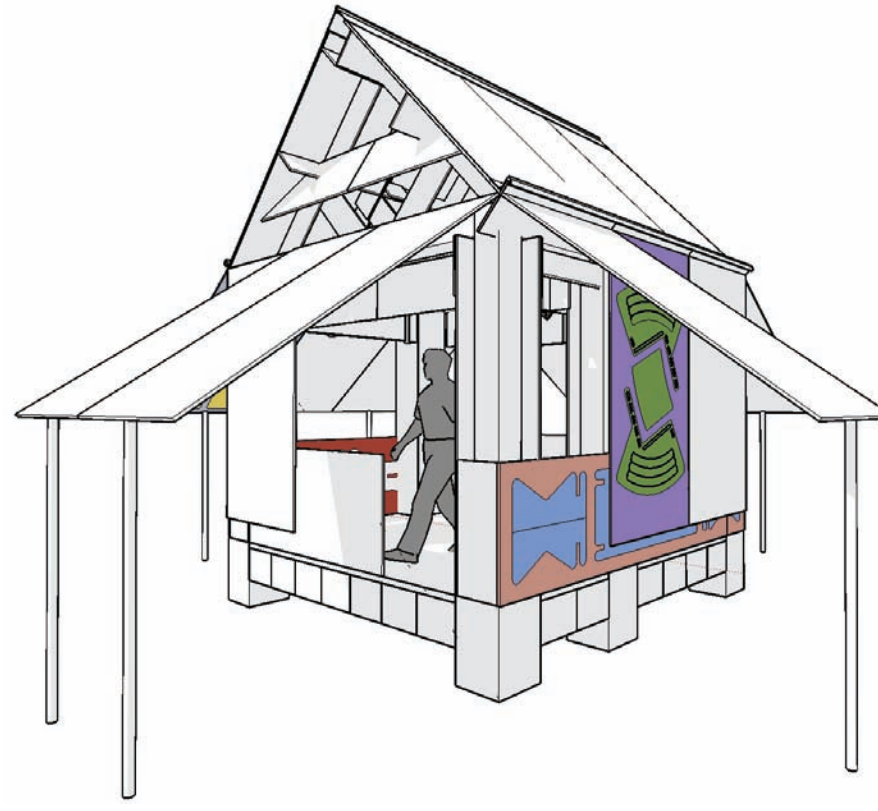

SELECTED PANELS OPEN

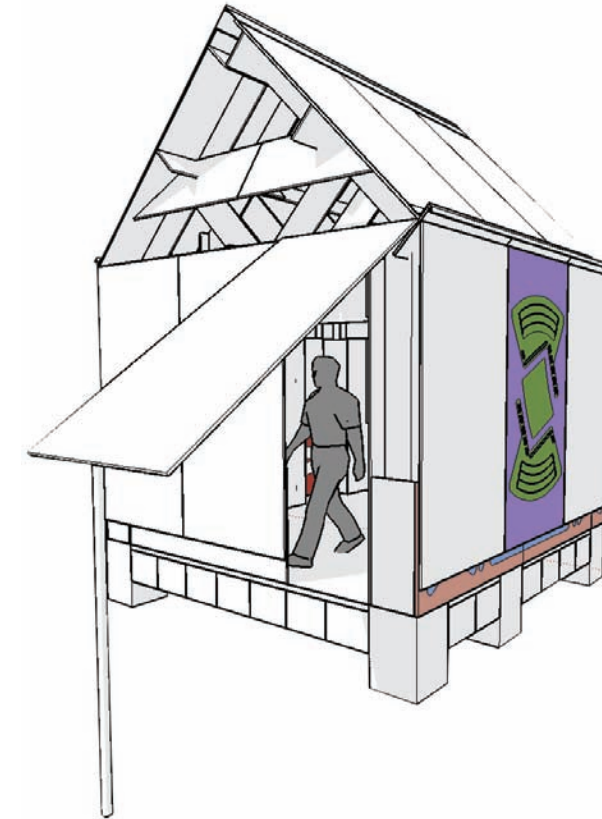

PANELS CLOSED

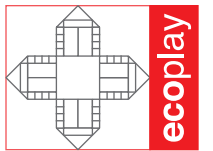

ecoplay

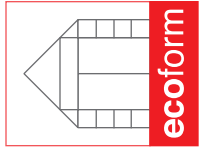

ecoform

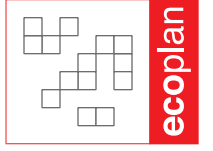

ecoplan



Island Nation Initiative

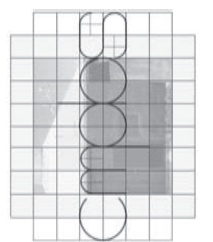

INFRASTRUCTURE

SOLAR SYSTEMS

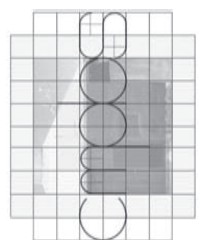
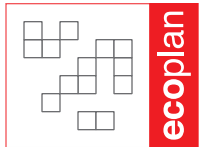
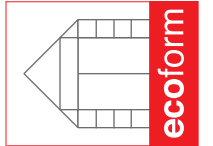
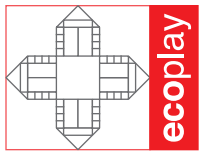
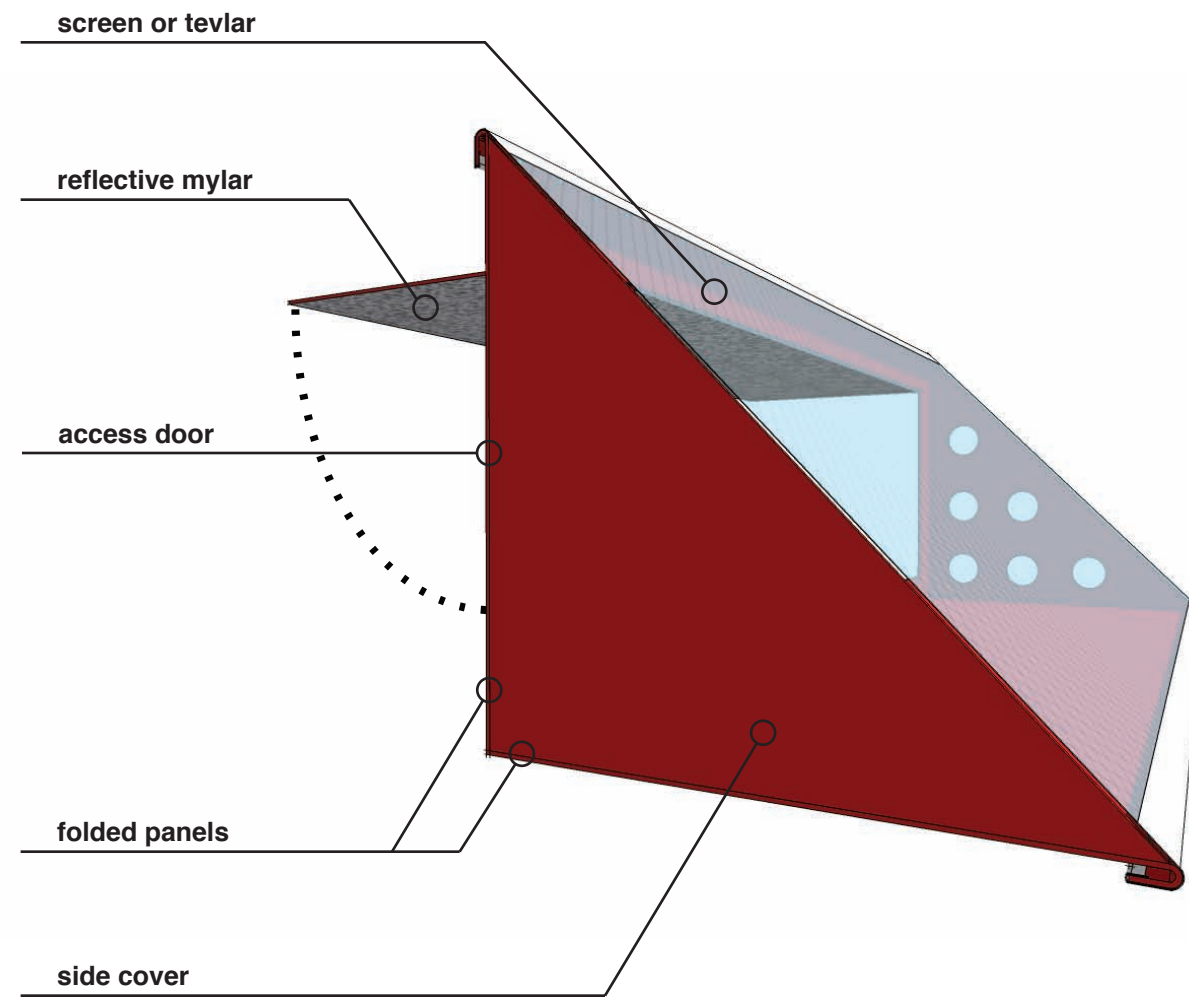
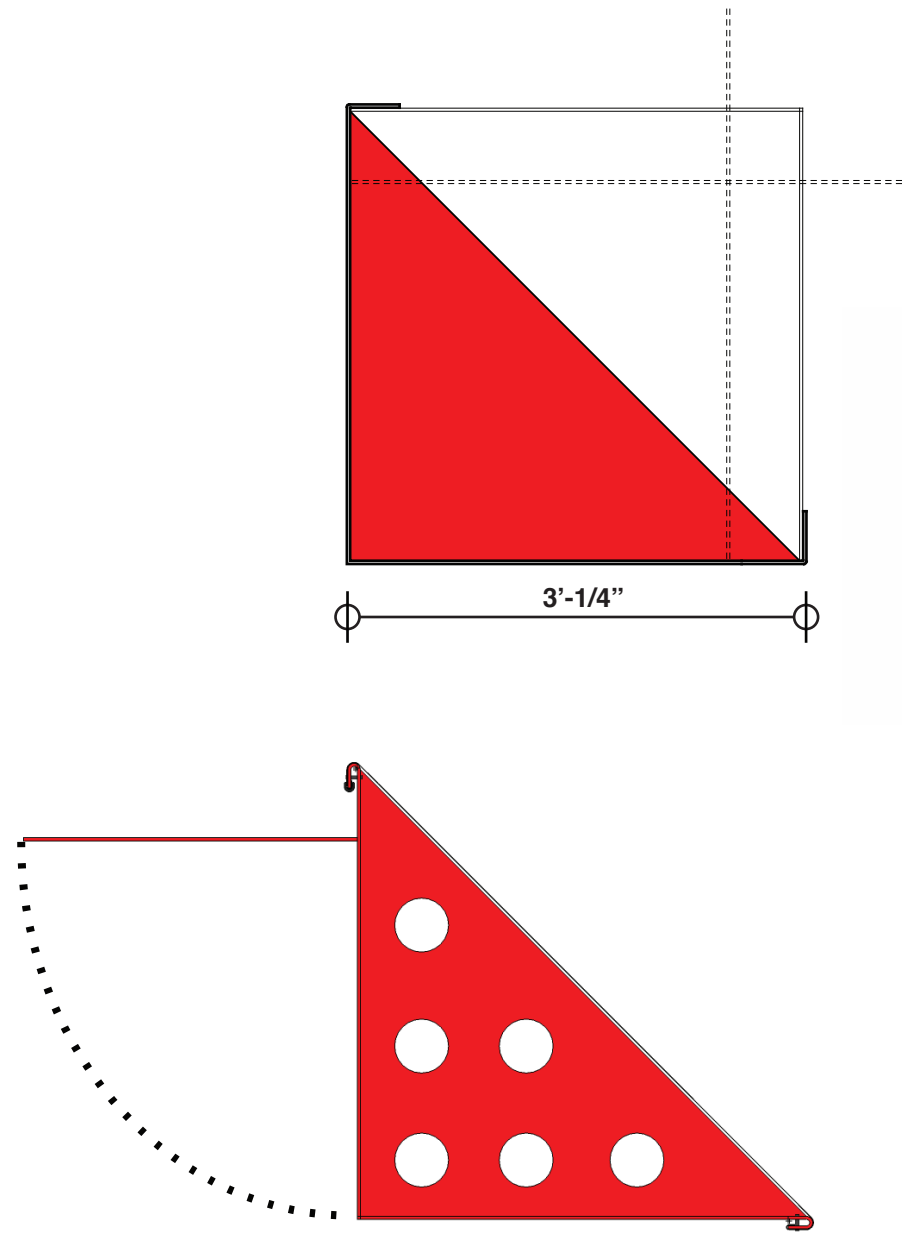

INFRASTRUCTURE

SOLAR STILL

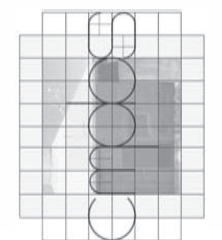
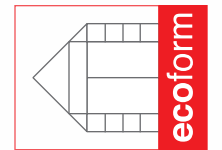
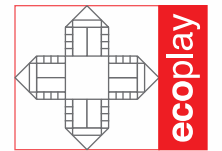
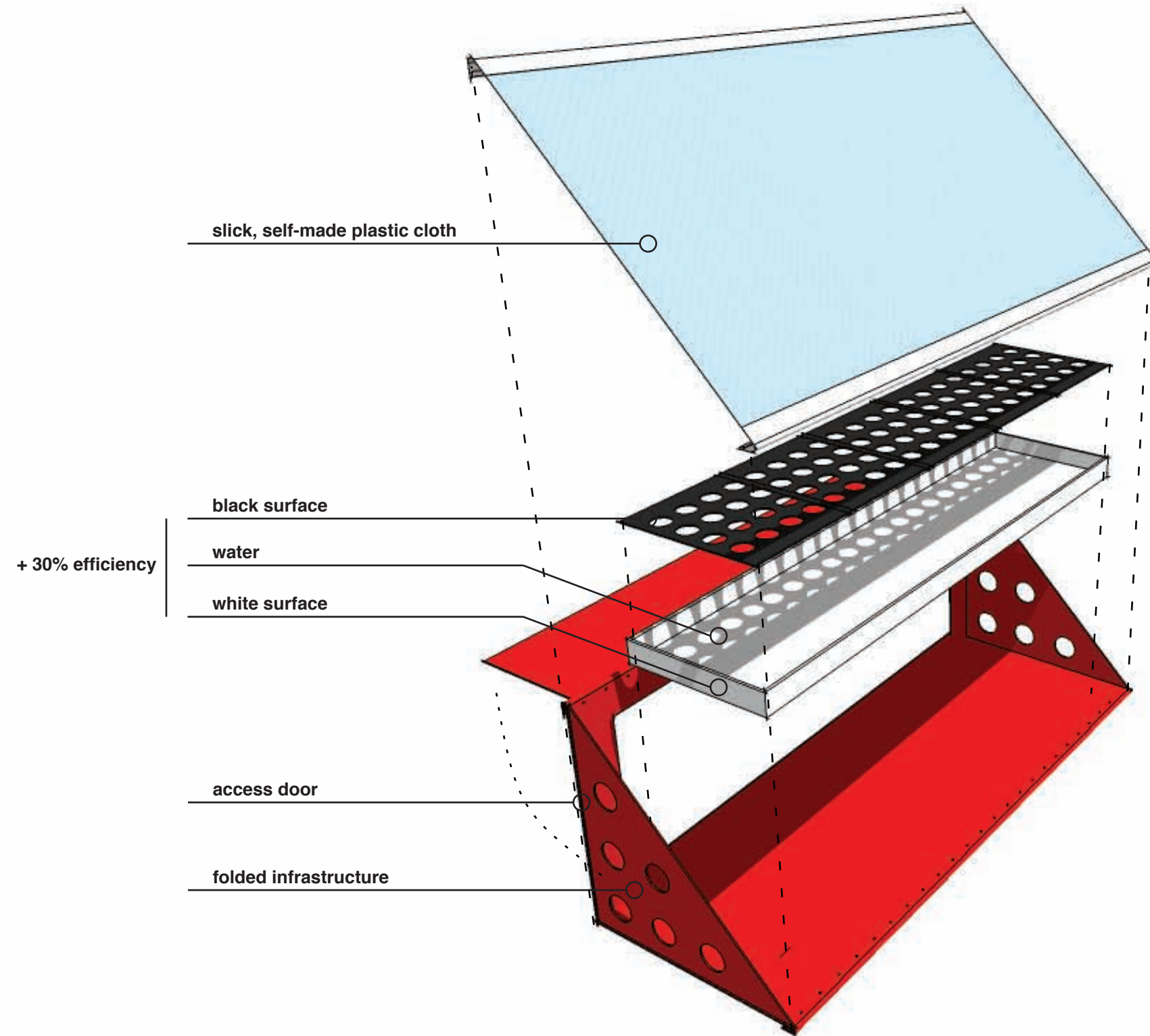

INFRASTRUCTURE

SCREENED GROWER

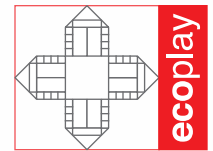
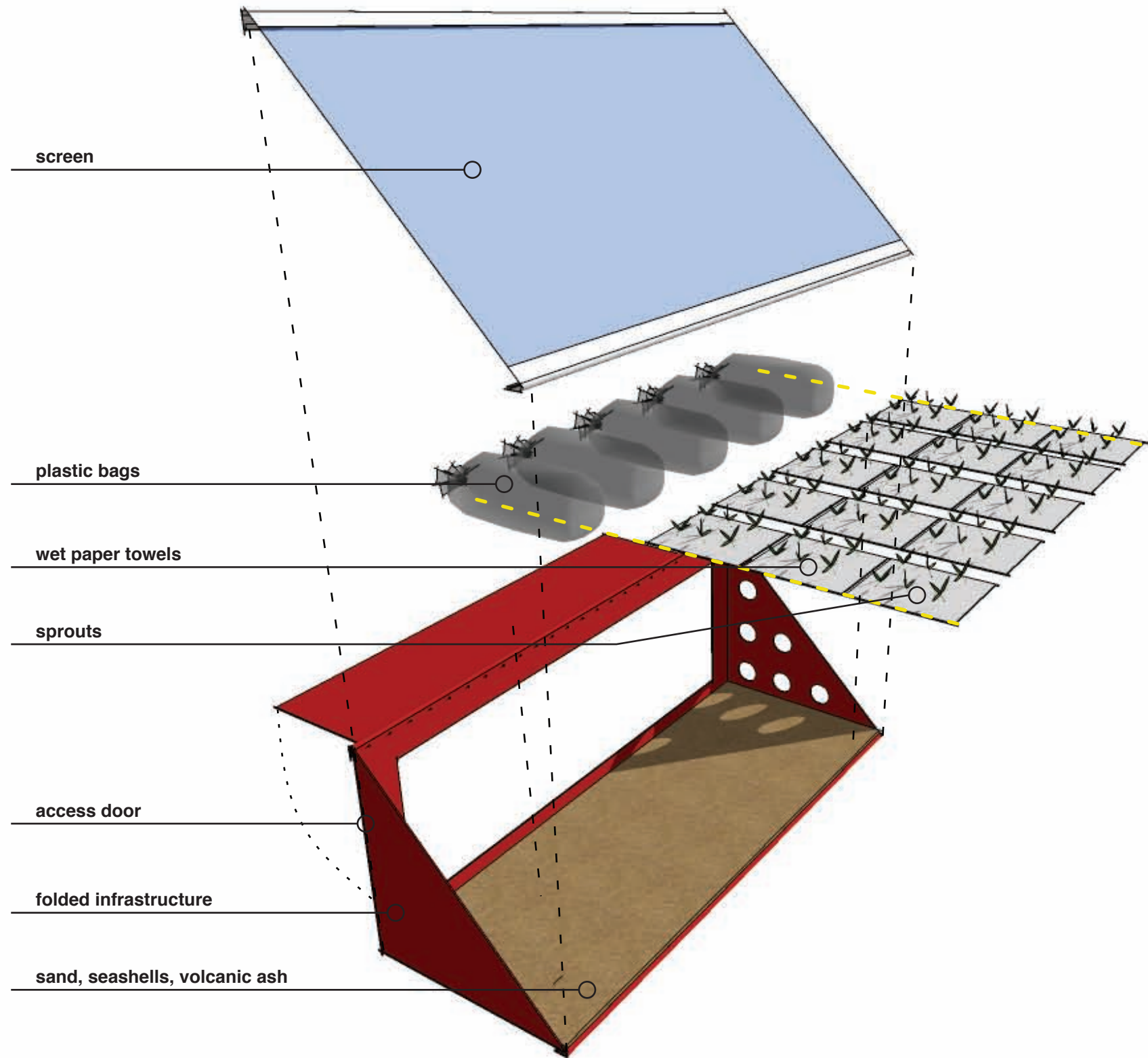

ecoplay

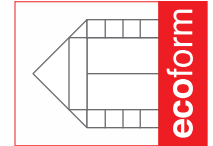

ecoform

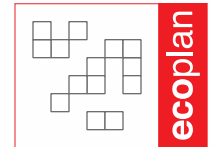

ecoplan



Island Nation Initiative

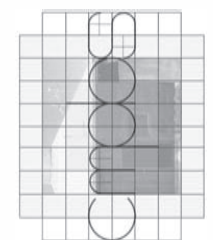

INFRASTRUCTURE

SOLAR COOKER

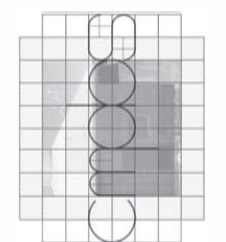
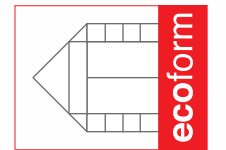
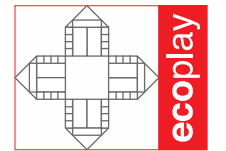
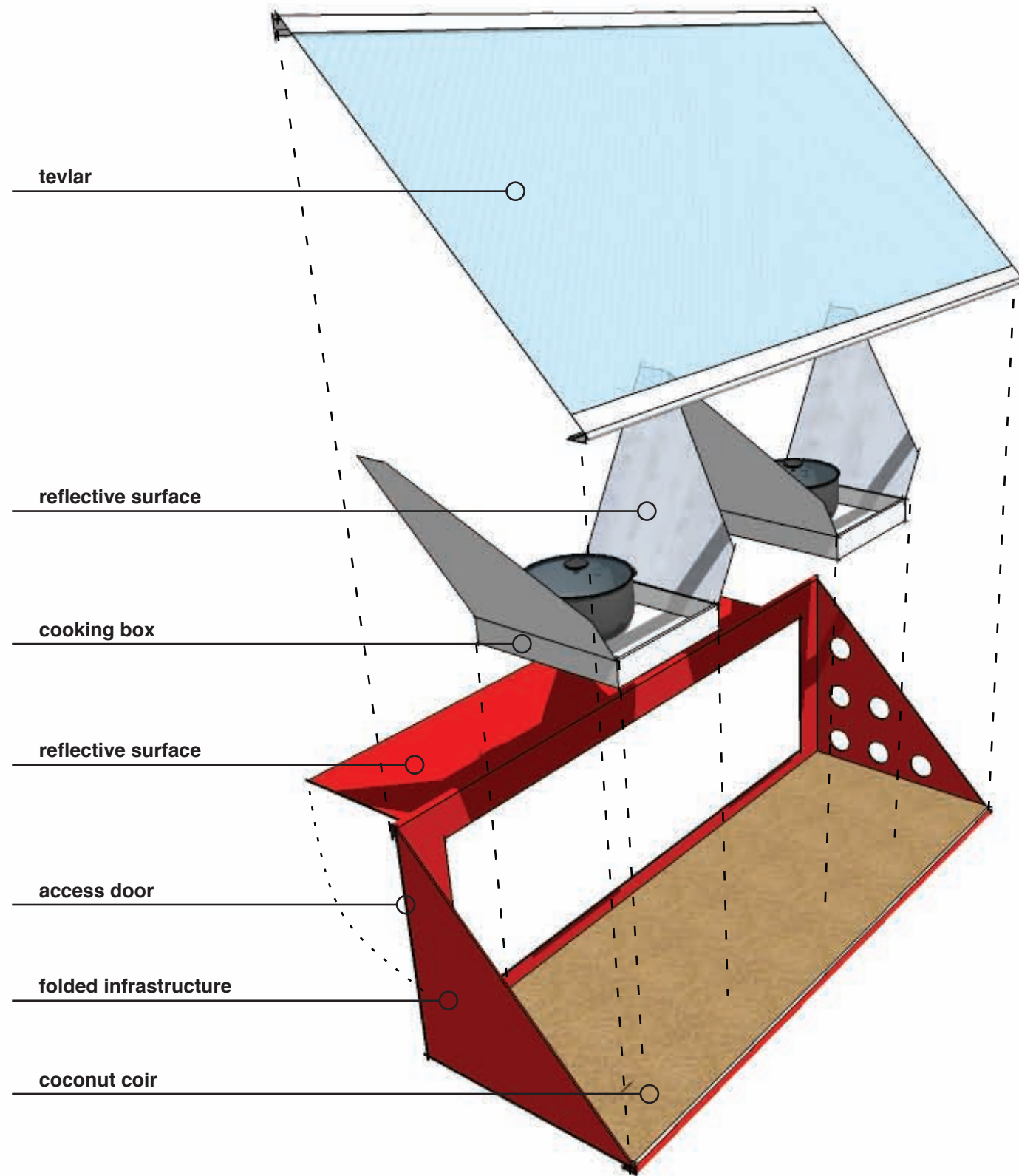

INFRASTRUCTURE

SOLAR DRIER

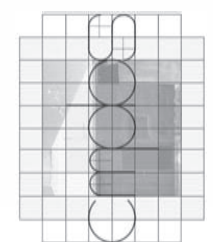
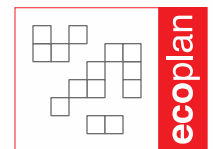
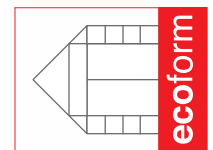
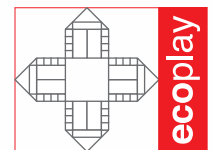
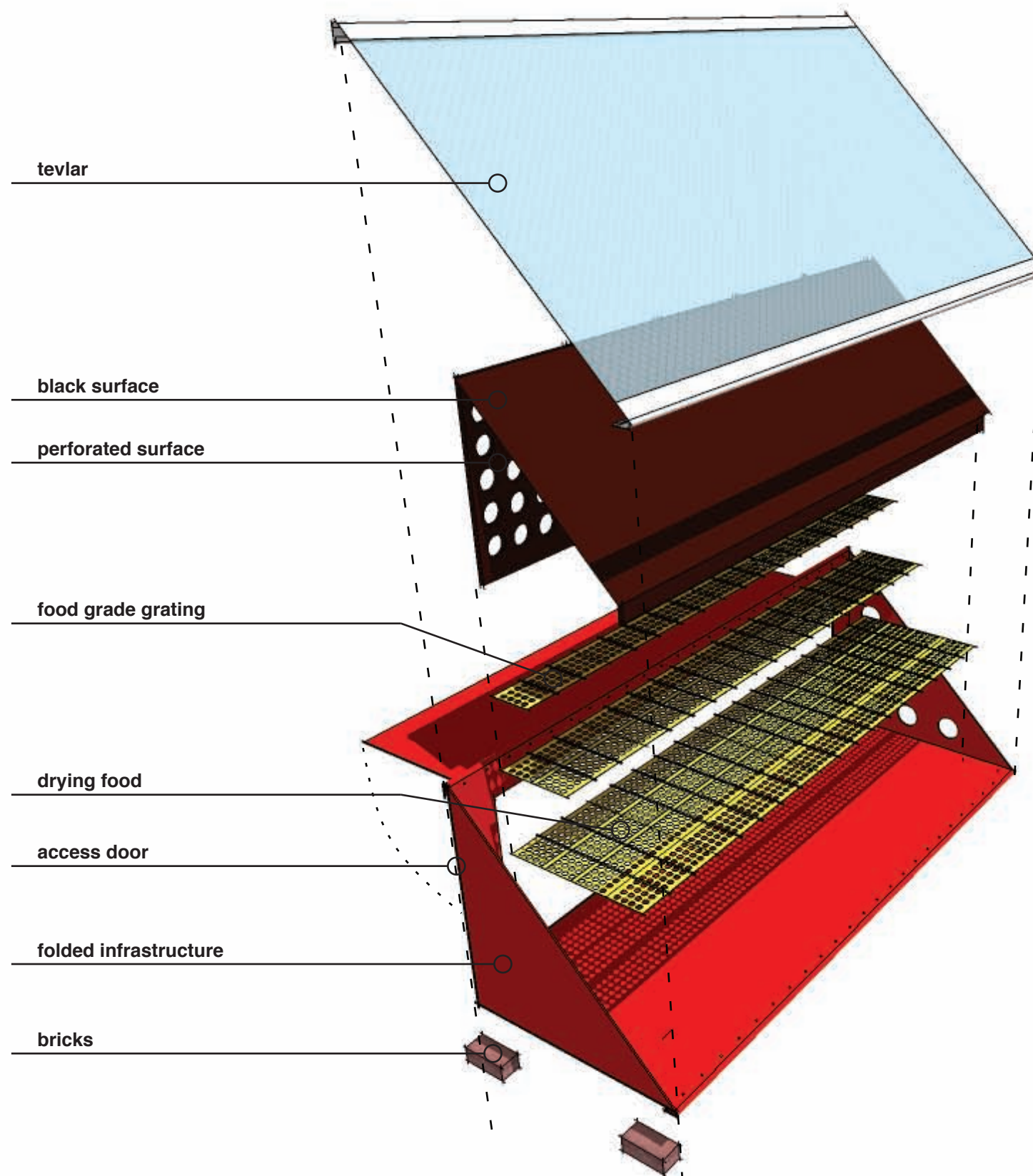

ECO BALANCE - LIFE CYCLE DESIGN HAITI

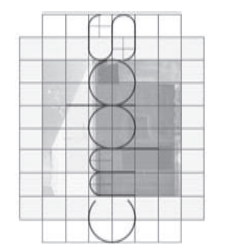
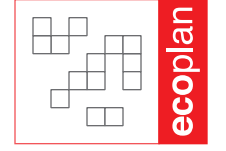
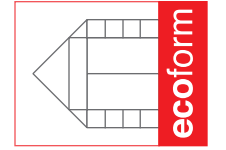
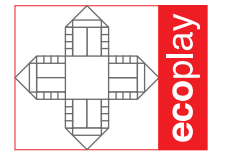
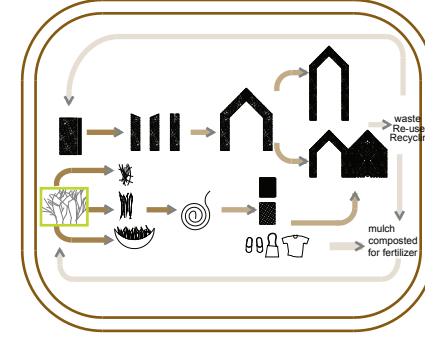
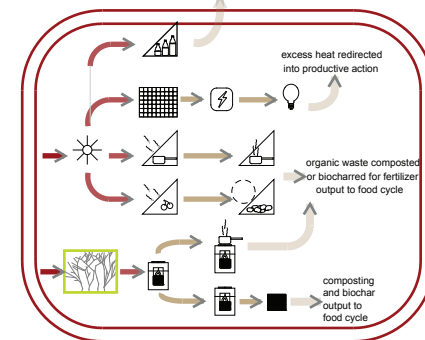
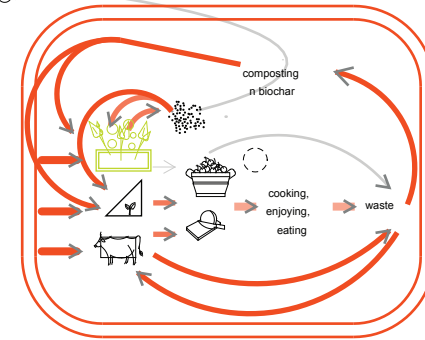
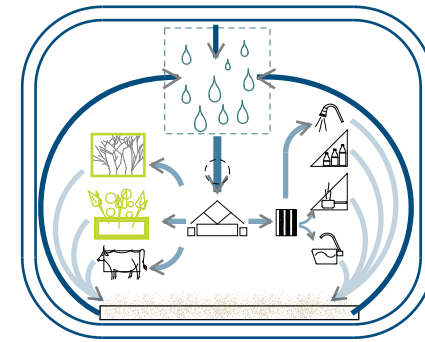
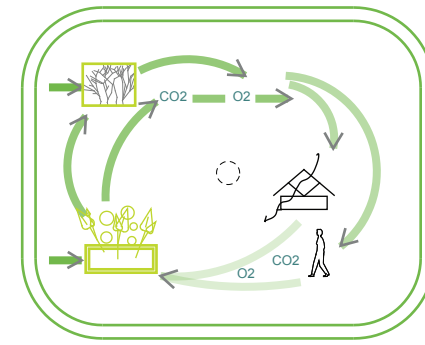
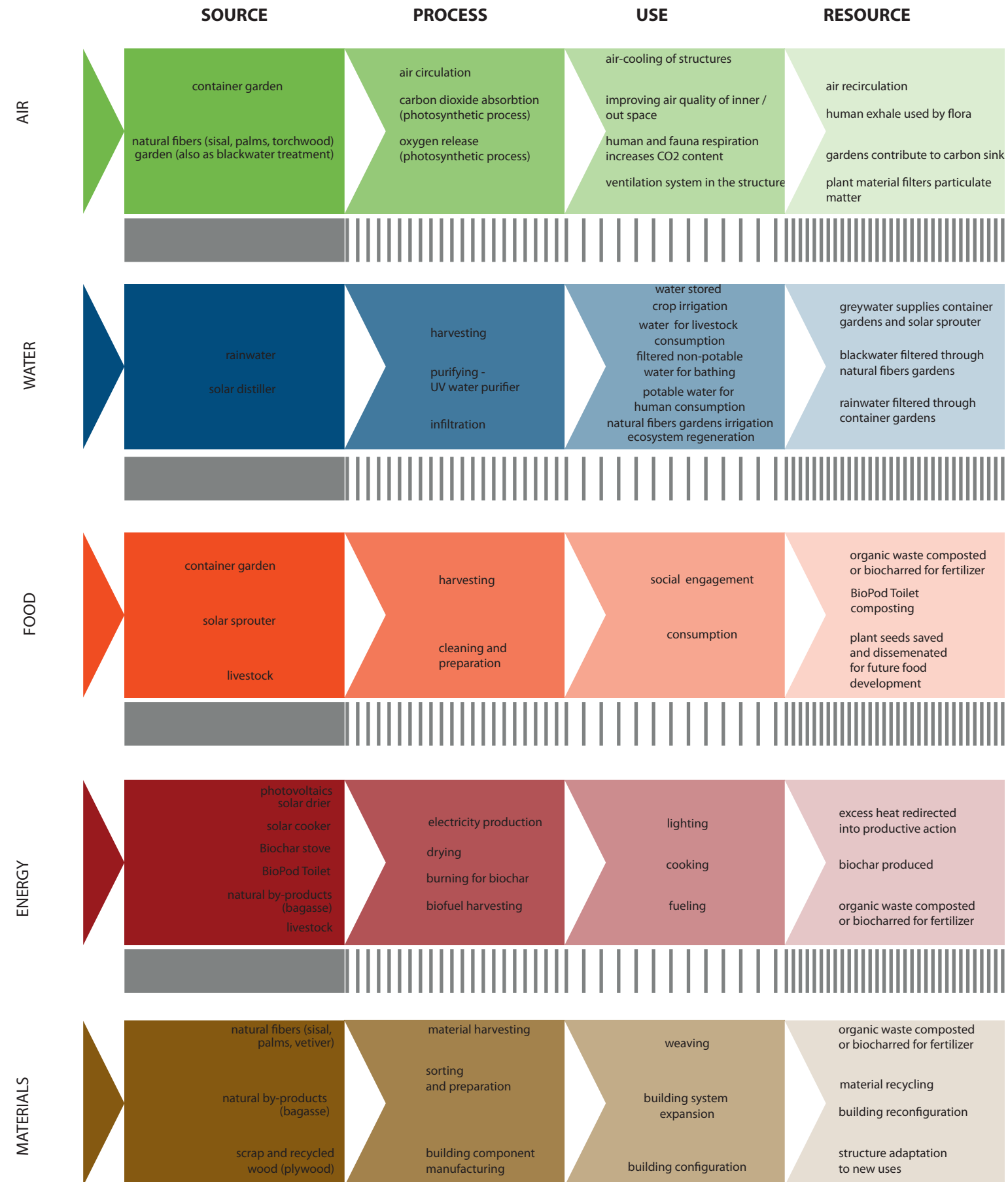

FOOD PROVISIONS

AVERAGE PRODUCTION SPACE NECESSARY PER CAPITA

HIGHEST PRODUCTION YIELDS:

- small scale
- high density
- labor intensive

general focus on vegetative diets greatly reduces resource needs

LAND AREA PER CAPITA FOR CROPLAND ONLY - VEGETARIAN DIET

DATA SOURCE	DESCRIPTION	Hectares	Acres
CURRENT CONDITIONS	World average, developed regions	0.7	1 3/4
	World average, less-developed regions	0.25	5/8
	U.S., average, industrialized	0.7	1 3/4
	India, present condition	0.3	3/4
	U.K., average, industrialized	0.13	1/2
	U. S., industrialized, highest recorded yields	0.05	1/8
CASE STUDIES	Swidden, vegetarian, New Guinea	0.08	1/5
	Allotment garden, UK (extrapolated)	0.08	1/5
	U. S. community garden, labor intensive, all-year	0.04	1/10
	China small scale farming, labor intensive	0.02	1/20
	U. S. small-scale, raised bed garden, all-year	0.01	1/40
THEORETICAL STUDIES	Odum	0.4 - 4	1 - 10
	Pimentel, et. al.	0.5	1 1/4
	Pfaundler	0.2 - 0.4	1/2 - 1
	FAO	0.2 - 0.4	1/2 - 1
	Clark	0.07	1/6
EXPERIMENTAL STUDIES	Biosphere II experiment, Arizona, USA	0.04	1/10

LAND AREA PER CAPITA FOR CROPLAND AND RANGELAND/PARTIAL MEAT DIETS

DATA SOURCE	DESCRIPTION	Hectares	Acres
CURRENT CONDITIONS	World average, developed regions	2.0	5
	World average, less-developed regions	0.8	2
	U. S., high meat diet - 100+ kg/year	2-4	5-10
	U. K. average	0.4	1
CASE STUDIES	New Guinea, Tsambaga (some hunting)	4.4	11
	Uganda, Dodo tribe	3.7	9
	U. S., self-sufficient small farm	0.4	1
	India, low meat diet - 2 kg/year	0.4	1
	New Guinea, swidden agriculture with livestock	0.2	1/2
THEORETICAL STUDIES	Clark	0.2	1/2

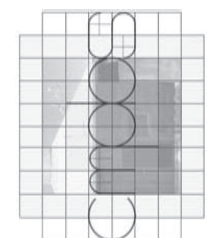
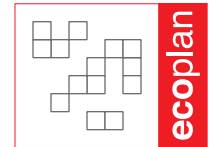
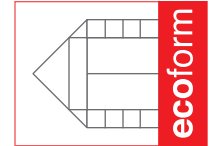
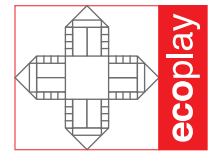

LANDSCAPE PRODUCTION

COMMUNITY GARDENS - ORGANOPONICOS

Extreme erosion has led to wide spread loss of land productivity

Community driven efforts are essential in coping

Container gardening has been shown to be highly effective



GENERAL EROSION CONTROL:

- tree planting
- container gardening
- permaculture

GARDEN CONTAINERS:

- mounding rubble
- tires
- building system components

SOIL RECHARGE:

- mounding soil
- food waste compost
- garden compost
- biochar
- composting toilets
- plantings

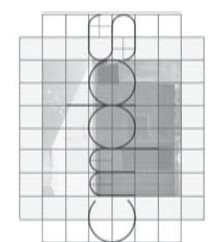
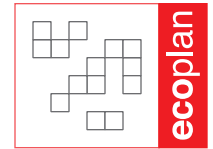
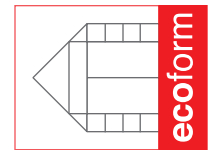
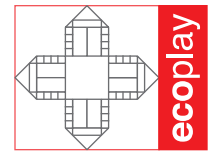

PLANT MATERIAL

STAPLE CROPS - VEGETABLES - HERBACEOUS FRUITS

STAPLE CROPS

Amaranthus spp. – hardy grain, species variable

Colocasia esculenta – malangá – taro – tropical

Pacific tuber

Chenopodium quinoa – hardy grain; will grow where corn will not

Maize spp. – corn

Manihot esculenta – manioc – cassava – starchy tubers pre-dating colonization

Oryza sativa – rice

Phaseolus spp. – beans

Saccharum spp. – sugarcane

Sorghum spp. – Giza sorghum variety; stalks for fuel sometimes worth more than grains

VEGETABLES AND HERBACEOUS FRUITS

Abelmoschus esculentus – okra

Ananus comosus – pineapple

Beta spp, par. *vulgaris* – chard

Celosia argentea – quail grass; large spinach-like leafy greens

Citrullus lanatus – watermelon

Curcubita moschata – seminole pumpkin; gourd

Fragaria spp. – strawberry

Luffa acutangula – gourd

Musa spp. – banana – flimsy, but rapid re-growth

Solanum lycopersicum var. *cerasiforme* – tomato – small cherry variety

CLIMBING VINES

Pachyrhizus erosus – jicama – vigorous legume w/ water-chestnut like tubers

Passiflora ligularis – sweet passionfruit – for higher climates, good commercial crop

Rubus glaucus – Andean blackberry – fruits year round

Vitis rotundifolia – Muscadine grape – native to FL; must be forced into dormancy

Vigna unguiculata – Thailand Long Bean



AMARANTH



MAIZE



CASSAVA



BANANA



MELON



QUINOA



RICE



TOMATO



TARO



BEANS

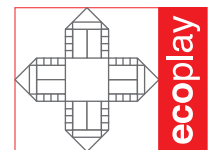

ecoplay

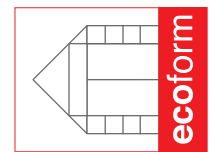

ecoform

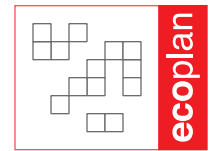

ecoplan



Island Nation Initiative

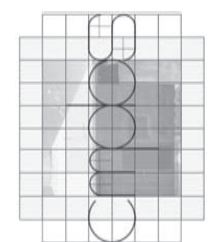

ecoplant

PLANT MATERIAL

TREES - MATERIALS - CASH CROPS

TREES

Amyris balsamifera, *elemifera* – torchwood – Haiti native, termite resistant, even green stems burn

Attalea crassispatha – endangered palm with a seed similar to coconut, but richer in fat and oils

Byrsonima crassifolia – Nance – sweet, edible fruit

Citrus spp.

Coccothrinax concolor, *fragrans*, *montana*, and *scoparia* – palm trees endemic to Haiti

Coffea spp.

Crescentia cujete – Calabash tree, medicinal

Juniperus gracilior – threatened species found only on Hispaniola

Mangifera indica L. – mango – fast-growing, popular fruit

Mimosa scabrella – Brazil native, fast growing, nitrogen fixating, prolific leaf shedder

Persea Americana – species of Avocado native to Hispaniola

Picrodendron baccatum – Jamaica Walnut – nut-bearing, grows in coastal limestone soil

Pinus occidentalis – pine that grows in poor, acidic soil

Pouteria sapote – mamey sapote – southern Mexican fruit, ornamental evergreen

Pseudophoenix lediniana – palm species found in the L-Ouest peninsula, near Leogane

Theobroma cacao – cocoa tree

ESSENTIAL OILS

Amyris balsamifera - torchwood; native to Haiti, good building material, repels termites, even green burns

Chrysopogon zizanioides – vetiver; roots grow straight down: non-invasive, good for soil stabilization

Citrus aurantifolia - key lime; shrubby and thorny, edible

Citrus aurantium - bitter orange; produces neroli oil, edible

TEXTILES

Agave sisalana – sisal

Gossypium hirsutum – cotton



TORCHWOOD



COFFEE



ATTALEA



MANGO

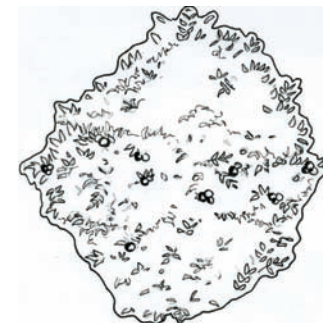

CITRUS



HISPANIOLAN PINE

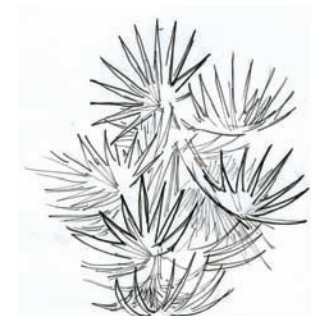

COCCOTHRINAX



CHOCOLATE

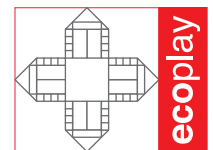

ecoplay

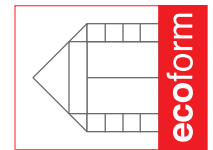

ecoform

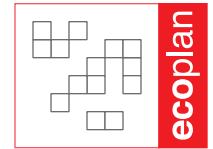

ecoplan

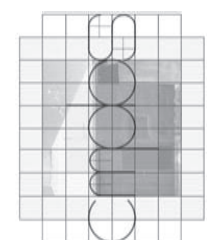

Constructed Wetlands

**Guidelines for Design, Construction and Permitting
of
Constructed Wetlands
for
On-site
Domestic Wastewater Treatment and Disposal**

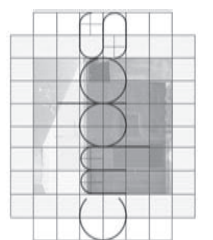
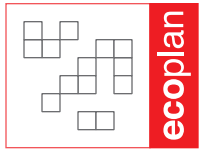
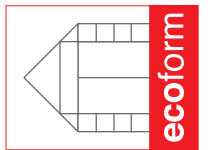
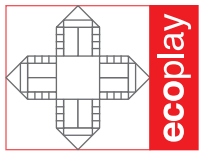
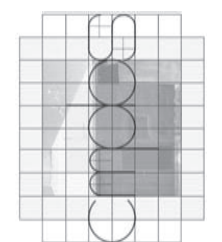
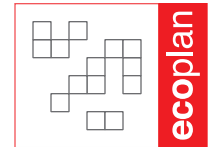
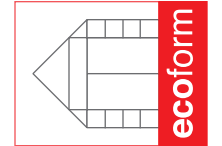
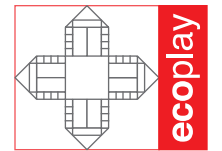
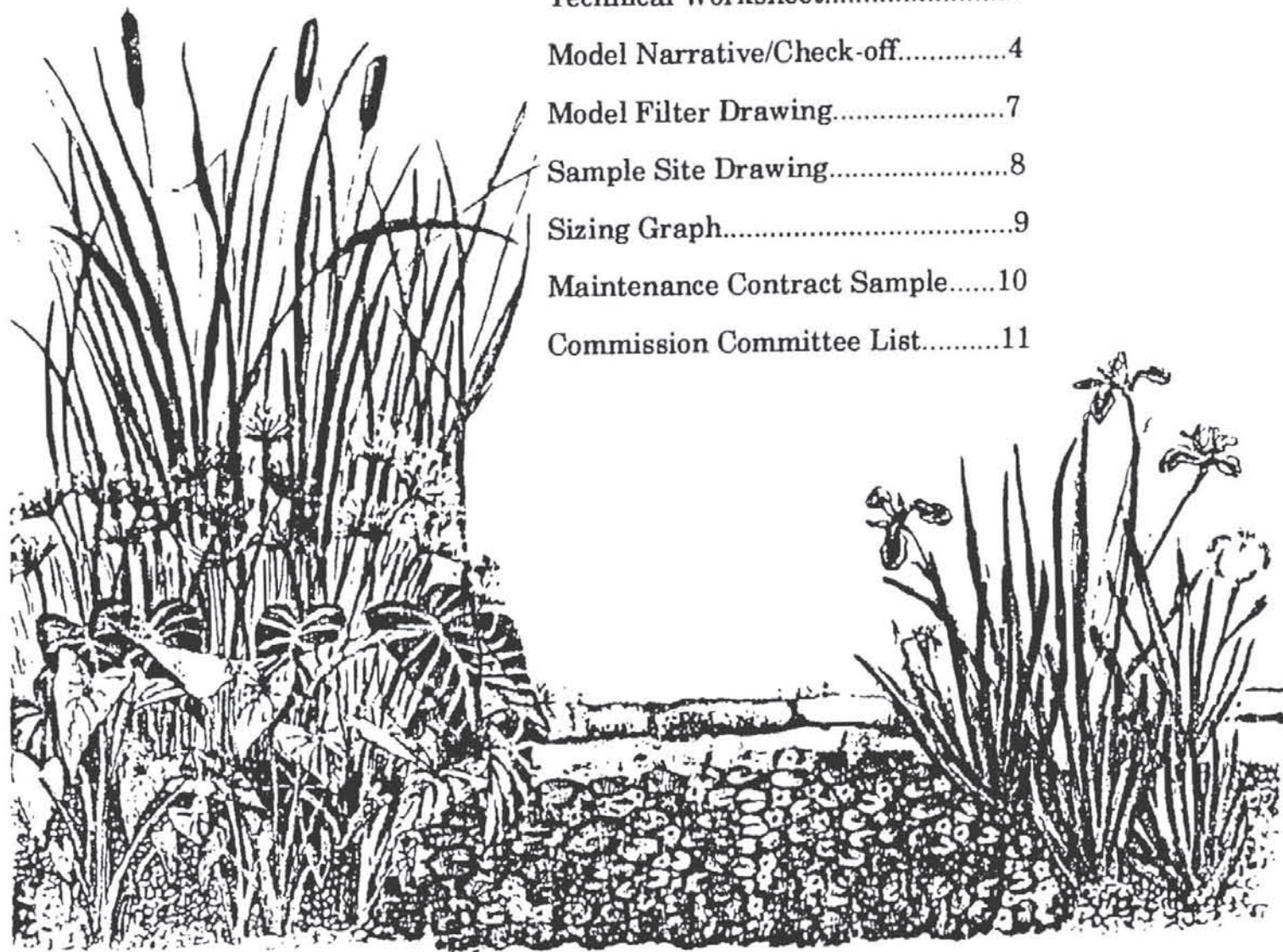

Table of Contents

How to Use this Manual.....	1
Technical Worksheet.....	2
Model Narrative/Check-off.....	4
Model Filter Drawing.....	7
Sample Site Drawing.....	8
Sizing Graph.....	9
Maintenance Contract Sample.....	10
Commission Committee List.....	11



Introduction to This Manual

Notes/Comments

For the last three years the Pineywoods Resource Conservation and Development Inc., in Nacogdoches, Texas, has provided leadership in transferring innovative waste treatment technology to East Texas. One of the most important technologies to be introduced and promoted is the small scale, low cost, constructed wetlands for single family dwellings. A TNRCC commission appointed committee with representatives from the Pineywoods RC&D, Texas A&M University, the TNRCC, and regional river authorities, has met and approved a pilot project for constructing a limited number of demonstration on-site wetlands systems in Texas.

This manual has been prepared to assist those who are interested in designing, installing, and permitting these wetlands to do so with a modicum of uniformity and ease. The design promoted in this manual has been simplified as much as possible in order to make it easy and inexpensive to install and inspect.

Included in this manual are a standard site analysis form, a standard design drawing and a standard design narrative which are to be used for a 3 bedroom (350 gpd) home application. An installer may use the drawing and narrative for a similar sized system. Any variances can be noted on the narrative check-off sheets. To use the drawing, photocopy the model and change the elevations to fit the actual project site. An installer will need to note the name of the project in the technical summary and on each sheet including the drawings.

This manual is also intended to assist permitting and inspection by TNRCC officials who can check off the designs and variances both in the permit request and then in the actual construction inspection. The same sheets turned in for a permit application can be used for approval and again for final inspection.

The permitting of these initial wetlands begins by an installer answering the site evaluation questions on the technical summary sheets at the beginning of this workbook. They must write in the name of the project for which this workbook is being submitted on each sheet of technical information so that if the pages are separated they can be returned to the correct file. These forms and model drawings do not replace the application forms already in use for innovative systems. This manual is intended to provide a clear model for many with little experience in wetlands design, construction and/or permitting to have a uniform set of guidelines to start with. An attachment of a model for a 225 (two bedroom) system will follow along with a useful sizing chart for other variances in soil and treatment quality.

Your feedback on the usefulness and completeness of this approach to design and permitting are welcome and should be sent to:

Mr. Warren Samuelson
C/O The Coordinator
Pineywoods RC&D
2900 Raguet St.
Nacogdoches Texas 77890.

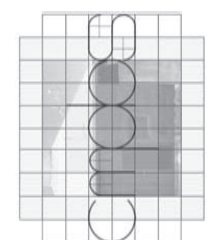
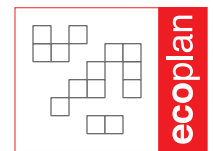
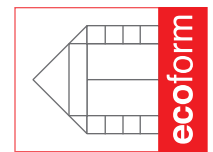
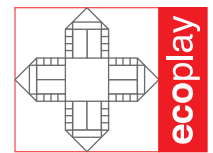

CONSTRUCTED WETLANDS

Constructed Wetlands Standard Site Study Guidelines

Notes/Comments

10. Elevation/fall from the house tie-in to the farthest edge of the disposal trenches = _____ ft.
11. Slope of property from the house to the farthest edge of the disposal trench = _____ ft. % of slope = _____ (rise divided by length)
12. Rainfall for this county = _____ in. annually.
13. Evaporation in this county = _____ inches annually.
14. Soil analysis done by: _____ License # _____
15. Percolation rate determined for cells = _____ min per in.
16. Percolation rate for trenches = _____ min. per inch.
17. Soil Ra. rating = _____ Soil is suitable _____ Unsuitable _____
18. Auger boring depth if completed to _____ feet. Mottles present ____yes____no.
19. High water table signs if any are: _____
20. Average number of days below freezing annually = _____
21. Fill out the model maintenance form at the back and turn it in signed with this workbook.

Additional Information or Items to Add:

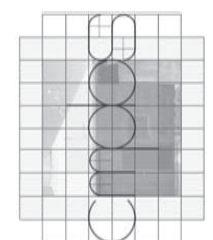
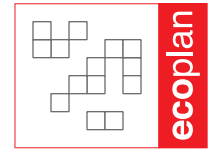
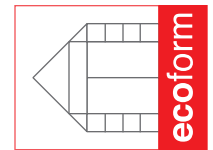
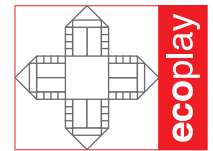

**Constructed Wetlands
Standard Site Study Guidelines**

**Constructed Wetlands
Design and Permit Form 350 GPD
For Single Family Residence**

Notes/Comments

[Please fill out this technical site questionnaire and the following narrative section of this form and turn them in with your drawing of the site, the treatment cell and the disposal system with both elevation and plan views.]

Technical Summary:

1. Number of Bedrooms = _____
2. Total gallons of water used from previous 12 months by adding all bills = _____
3. Find average monthly usage by dividing line 2 by 12 = _____
4. Find daily use by dividing line 3 by 30 = _____
5. Size of septic tank is determined by flow as follows:
(Insert TNRCC sizing chart)
6. Size of septic tank for this project = _____
7. Septic filter fitted on final outfall piping of septic tank required.
Type to fit = _____
8. Fall determined between outfall of septic tank and the water level of the first cell = _____ inches.
9. Proposed elevation (fall) from the outfall pipe of the last cell to the distribution pipe of the lateral or disposal trenches = _____ inches.

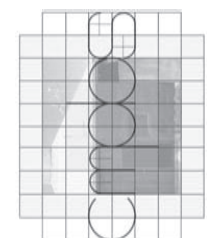
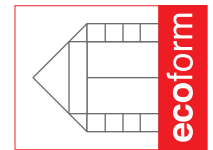
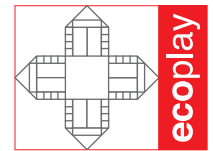

CONSTRUCTED WETLANDS

Constructed Wetlands Standard Design Narrative Guidelines

#	Guidelines for Component Selection	Guidelines for Installation	Project Name/	Inspection Comments
1	Tie in to existing sewer pipe drain:	Select rubber (Fernco type) gasket with stainless steel screw strap to tighten.	<input type="checkbox"/> <i>Varies Explain:</i> <input type="checkbox"/> Complies	<input type="checkbox"/> Not okay <i>Reason:</i> <input type="checkbox"/> Okay
2	Clean-out:	Place clean-out within 3 ft. of the house foundation or as close to the tie-in as possible.	<input type="checkbox"/> <i>Varies Explain:</i> <input type="checkbox"/> Complies	<input type="checkbox"/> Not okay <i>Reason:</i> <input type="checkbox"/> Okay
3	Piping from the house to the septic tank can be 3 or 4 inch diameter solid PVC pipe: S&D ASTM SDR ASTM:	Install pipe selected with minimum fall of of 1/8 inch per foot of pipe.	<input type="checkbox"/> <i>Varies Explain:</i> <input type="checkbox"/> Complies	<input type="checkbox"/> Not okay <i>Reason:</i> <input type="checkbox"/> Okay
4	Septic tank/s must be sized according to the number of bedrooms and/or daily flow: 3 bedrooms = 350 gpd 350 gpd requires 1000 gallon capacity, two chambered septic tank.	Install the septic tank as close to the ground level as possible. Minimum coverage of 6 inches of topsoil, maximum of 24 inches.	<input type="checkbox"/> <i>Varies Explain:</i> <input type="checkbox"/> Complies	<input type="checkbox"/> Not okay <i>Reason:</i> <input type="checkbox"/> Okay
5	A septic filter must be fitted to the outfall pipe in place of the normal Tee fitting to prevent solids entering the wetlands media. [Do not use a screen, only a certified filter.]	Center filter in the manhole opening. Glue the body of the filter to the outfall pipe so that the removable cartridge in the middle of the filter can be easily reached and pulled out for inspection and cleaning.	<input type="checkbox"/> <i>Varies Explain:</i> <input type="checkbox"/> Complies	<input type="checkbox"/> Not okay <i>Reason:</i> <input type="checkbox"/> Okay
6	Piping from the septic tank to the wetlands treatment cell must comply with the same specifications as that from the house to the septic tank.	Install all pipes with a minimum fall of 1/8 inch per foot.	<input type="checkbox"/> <i>Varies Explain:</i> <input type="checkbox"/> Complies	<input type="checkbox"/> Not okay <i>Reason:</i> <input type="checkbox"/> Okay

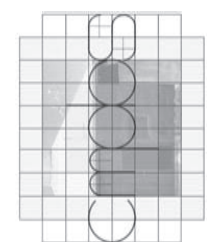
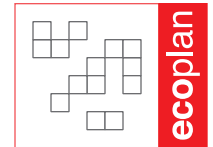
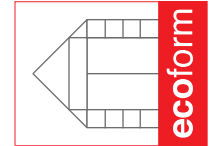
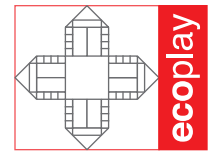

CONSTRUCTED WETLANDS

Constructed Wetlands Standard Design Narrative Guidelines

#	Guidelines for Component Selection	Guidelines for Installation	Project Name/ Plan for this Project:	Inspection Comments
7	A two-cell filter system with a total of 330 sq. ft. area will be constructed to receive septic tank overflow and treat this wastewater to 30/30 mg/l of BOD and TSS.	Total length is 33 ft. x 10 ft. wide measured from the top inside berm to opposite top inside berm. Ideal 1 : w ratio is 3:1. [2: 1 or 4:1 to fit a particular site] Build a 3 ft. wide berm all around the system.	<input type="checkbox"/> Varies <i>Explain:</i> <input type="checkbox"/> Complies	<input type="checkbox"/> Not okay <i>Reason:</i> <input type="checkbox"/> Okay
8	Cell A is a deep zone as the first stage of treatment to receive septic tank inflow. A deep zone serves to mix and distribute water. Fill this area with an approved media and proper plants.	The depth of the normal water level in Cell A is 24 inches. Ideal configuration of Cell A is 10 ft. wide x 12 ft. long. Media may be washed river rock or chipped tires and should cover water by a minimum of 2 inches.	<input type="checkbox"/> Varies <i>Explain:</i> <input type="checkbox"/> Complies	<input type="checkbox"/> Not okay <i>Reason:</i> <input type="checkbox"/> Okay
9	Backflow from the treatment cell to the septic tank must be prevented. Freeboard is created by creating space between the normal water level and the cell berm top and/or the septic tank outfall pipe.	The septic tank outfall pipe elevation must be equal to or greater than the outside berm elevation around the cell. The distance between the berm top and the normal water level is the freeboard of this system.	<input type="checkbox"/> Varies <i>Explain:</i> <input type="checkbox"/> Complies	<input type="checkbox"/> Not okay <i>Reason:</i> <input type="checkbox"/> Okay
10	Freeboard for the first stage of the treatment cell must not be less than 6 inches and ideally 12 inches where annual rainfall is equal to evaporation. Freeboard for the second stage will be the same.	Use the excavated soil to build up a berm to provide added depth to the cell. Hold the berm level around the entire system. Cut in the aeration berm only after the cells are complete.	<input type="checkbox"/> Varies <i>Explain:</i> <input type="checkbox"/> Complies	<input type="checkbox"/> Not okay <i>Reason:</i> <input type="checkbox"/> Okay
11	An aeration berm will be constructed at the end of Cell A. It will force water up near the surface for contact with air as it flows to the second stage. This berm sets the water level for the entire system.	Construct a berm that extends the width of the cell. The height of this berm creates the normal water level for the system. The width of the berm is not less than 24 inches and not more than the outside berm width. Line the berm and cover with minimum 2 inches of media.	<input type="checkbox"/> Varies <i>Explain:</i> <input type="checkbox"/> Complies	<input type="checkbox"/> Not okay <i>Reason:</i> <input type="checkbox"/> Okay
12	Following the aeration berm the final stage of treatment occurs in a shallow zone 2/3 the length of entire cell filled with an approved media.	Excavate Cell B to a depth of 14 inches below the aeration berm and fill with 14 inches of media. Cell area is 180 sq. ft.(10 ft wide x 18 ft. long). Normal water depth is 12 inches. Fall from the aeration berm to water level will vary with evaporation.	<input type="checkbox"/> Varies <i>Explain:</i> <input type="checkbox"/> Complies	<input type="checkbox"/> Not okay <i>Reason:</i> <input type="checkbox"/> Okay

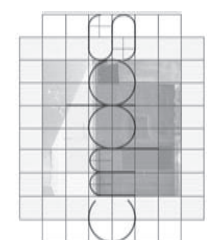
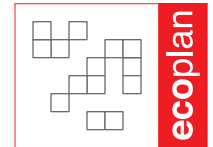
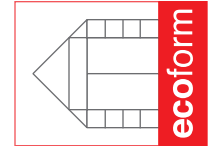
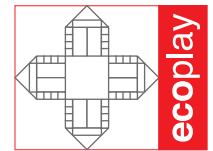

CONSTRUCTED WETLANDS

Constructed Wetlands Standard Design Narrative Guidelines

#	Guidelines for Component Selection	Guidelines for Installation	Project Name/ Plan for this Project:	Inspection Comments
13	Overflow/water level control piping from the cell to the drainfield:	Excavate a narrow channel through the end berm of Cell B and place a 4 in. PVC pipe and Tee fitting at the desired water level depth of 12 inches. Place short, perforated extensions on this Tee to 3 ft. wide and allow the ends to be open.	<input type="checkbox"/> <i>Varies Explain:</i> <input type="checkbox"/> Complies	<input type="checkbox"/> Not okay <i>Reason:</i> <input type="checkbox"/> Okay
14	Backflow control must be prevented from the drainfield trenches into Cell B.	The outflow pipe from Cell B to the drainfield must be at least 24 inches above the drainfield manifold piping to ensure that no water flows back into Cell B even if the trenches are	<input type="checkbox"/> <i>Varies Explain:</i> <input type="checkbox"/> Complies	<input type="checkbox"/> Not okay <i>Reason:</i> <input type="checkbox"/> Okay
15	Flood control drainage around the entire system must be constructed to prevent inflow of storm water.	In addition to the berms constructed around the entire system, a drain 8 ft. wide at same elevation as the normal water level in the system must be created beyond where the outside	<input type="checkbox"/> <i>Varies Explain:</i> <input type="checkbox"/> Complies	<input type="checkbox"/> Not okay <i>Reason:</i> <input type="checkbox"/> Okay
16	The correct type of plants in Cell A are necessary to ensure effective treatment. Cell A plants must be added immediately before tie in. Cell B plants can be added as desired and water level is sufficient to support plantings.	Cell A plants must be true hydrophytes that can sustain growth when their roots and stems are flooded. These plants include cattails, reeds, rushes and thalia. Cell B plants are ornamental bog varieties and include canna, iris, taro, elephant ear.	<input type="checkbox"/> <i>Varies Explain:</i> <input type="checkbox"/> Complies	<input type="checkbox"/> Not okay <i>Reason:</i> <input type="checkbox"/> Okay
17	Security and access to the treatment cell must be addressed to prevent contact with septic water and contaminated media.	Measures should be taken to exclude small children and pets from contact with the media in the treatment cells which may contain viruses and coliforms. Some warning and perhaps a low fence is recommended.	<input type="checkbox"/> <i>Varies Explain:</i> <input type="checkbox"/> Complies	<input type="checkbox"/> Not okay <i>Reason:</i> <input type="checkbox"/> Okay
18	Final disposal trenches. Because the wastewater overflowing from the treatment cell will be treated, the rate of percolation should increase and thus the total area for final disposal can be reduced.	Disposal trench total area is Total disposal area for 350 gpd @30/30 = 969 sq. ft. less 330 sq. ft. of filter = 639 sq. ft. of diel line. Recommend 3 trenches 3 ft. wide and 75 ft. long if on contour.	<input type="checkbox"/> <i>Varies Explain:</i> <input type="checkbox"/> Complies	<input type="checkbox"/> Not okay <i>Reason:</i> <input type="checkbox"/> Okay

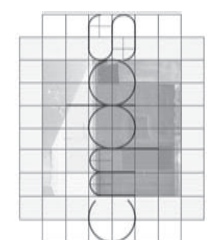
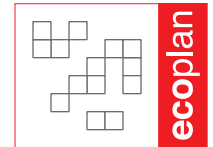
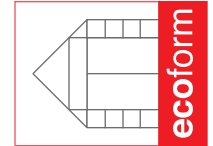
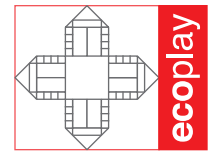

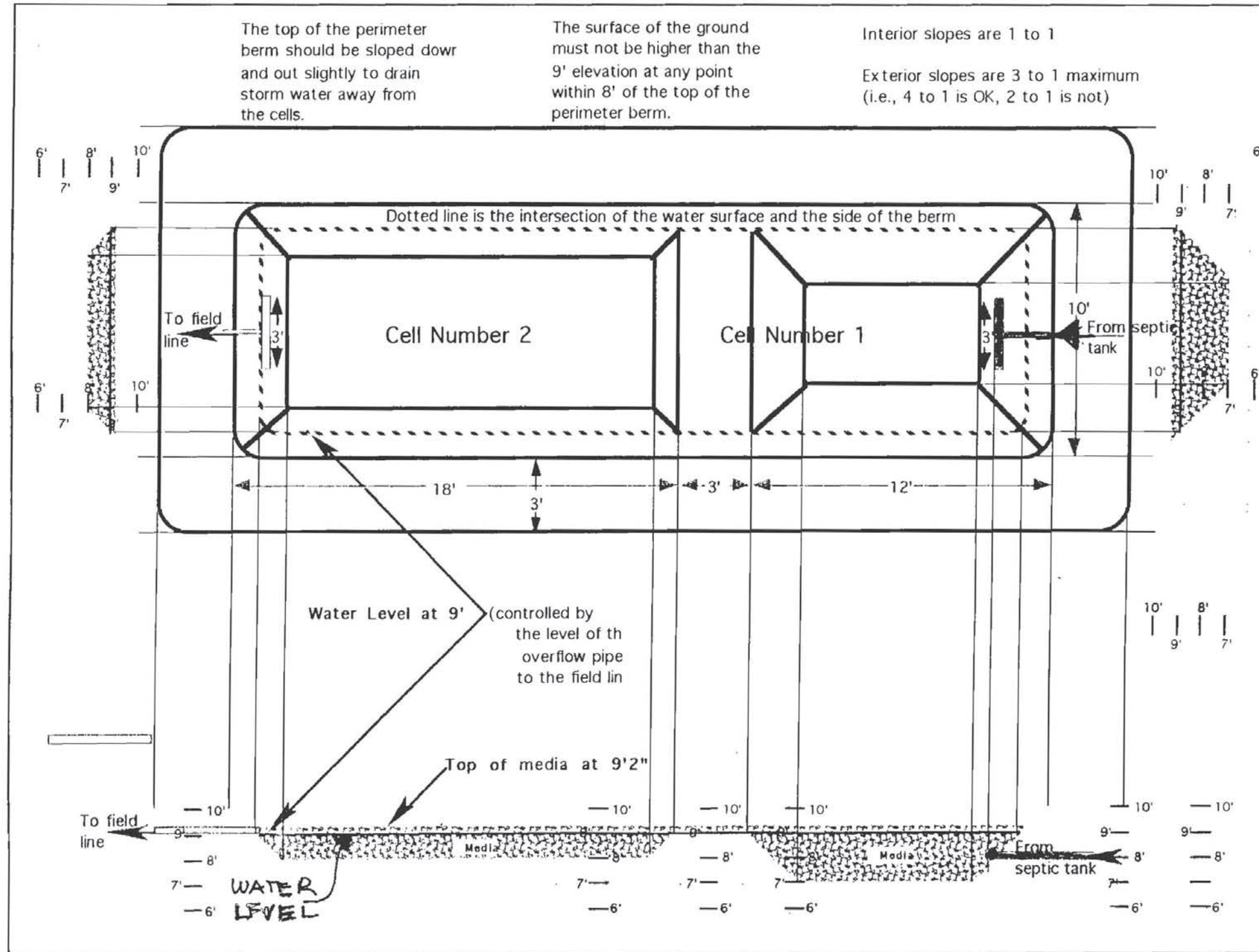

Model 350 GPD Design

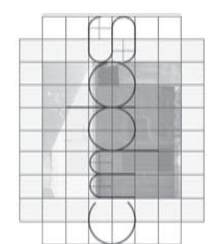
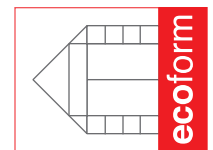
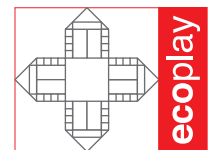

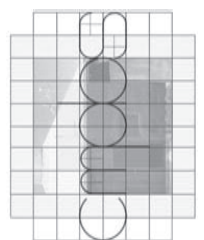
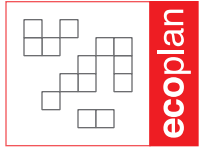
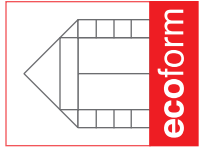
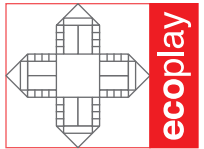
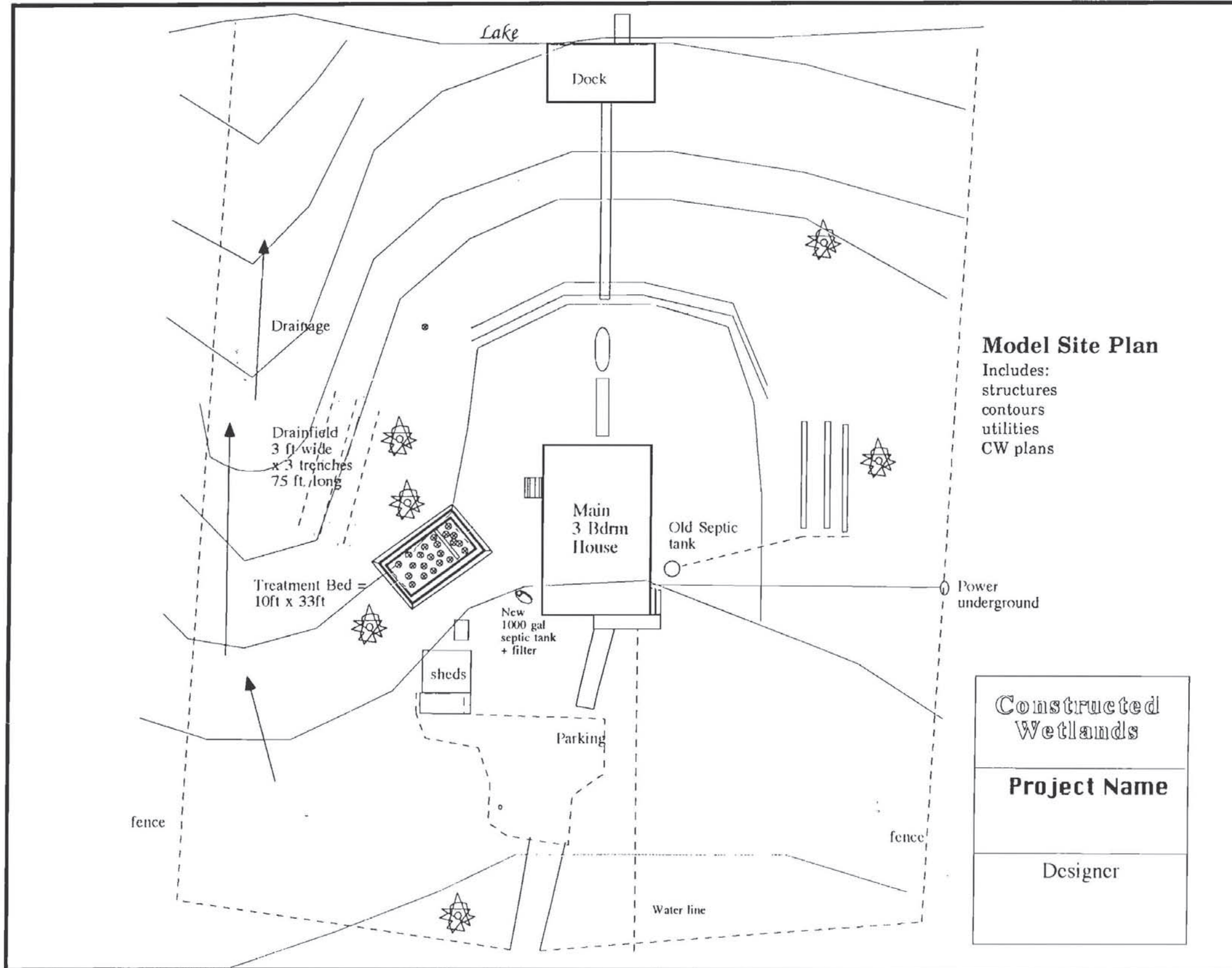

CONSTRUCTED WETLANDS

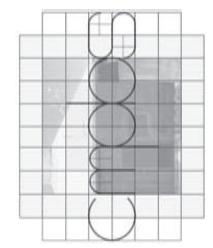
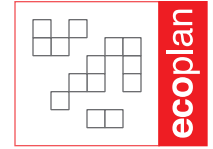
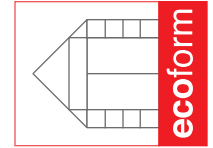
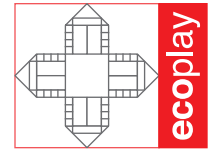
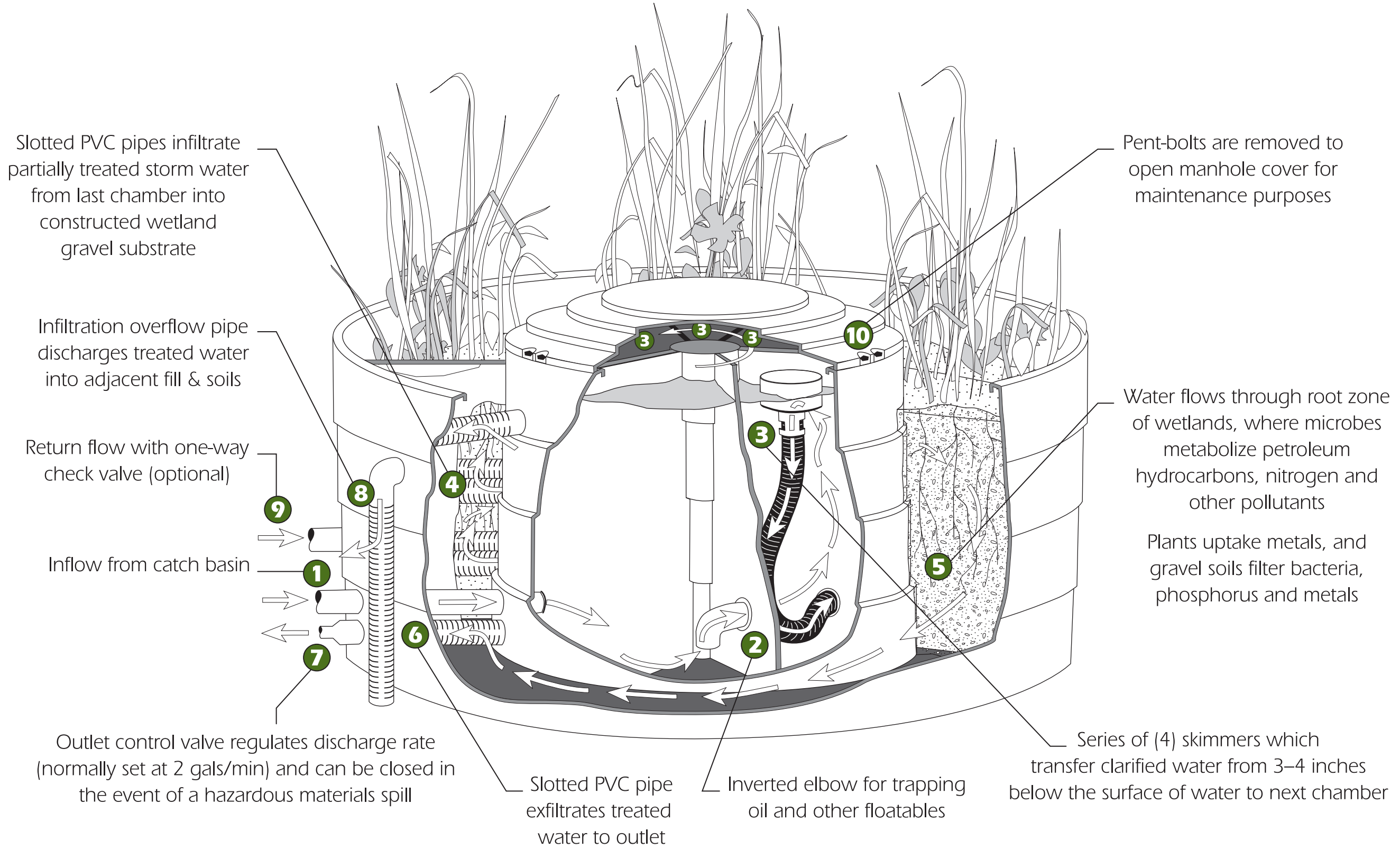

ECOPLAY



Quilting as community planning

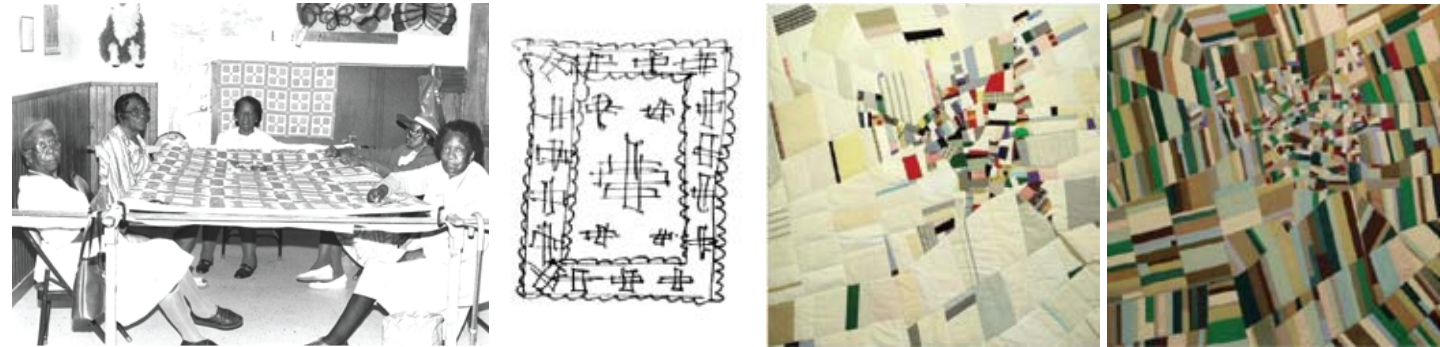

Game Table

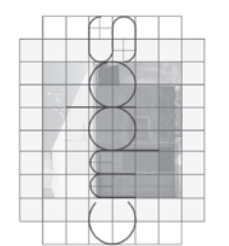
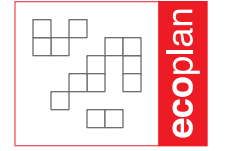
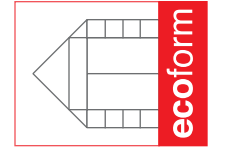
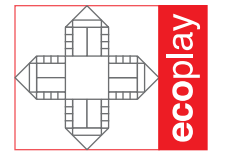
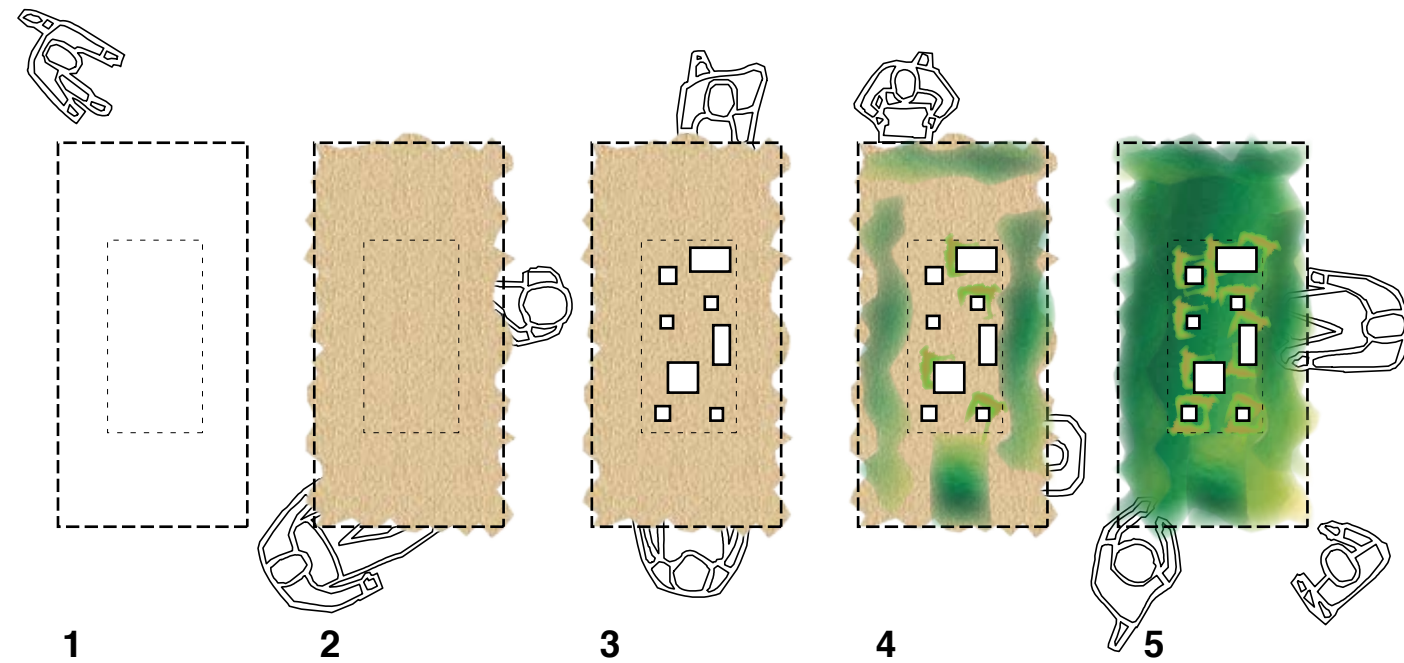

AUSTIN HATIAN BIKE TRUCK

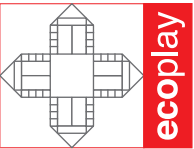
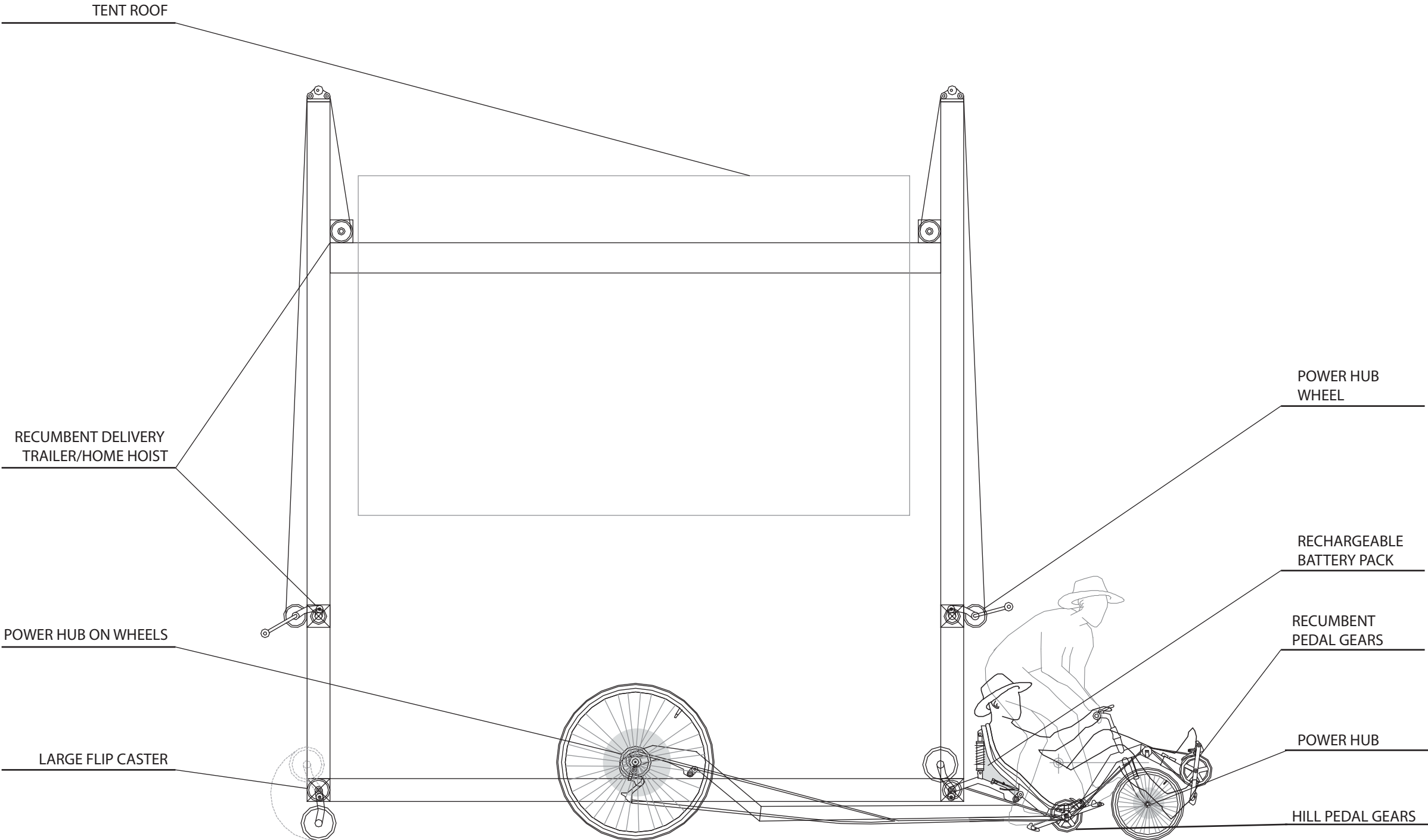

ecoplay

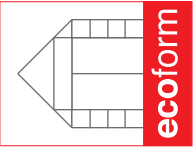

ecoform

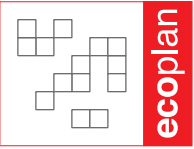

ecoplan



Island Nation Initiative

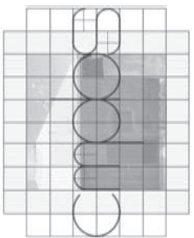

CUMC

AUSTIN HATIAN BIKE TRUCK

material delivery

moving of roof tent

lifting roof up

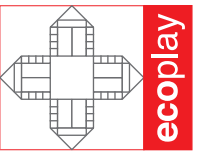
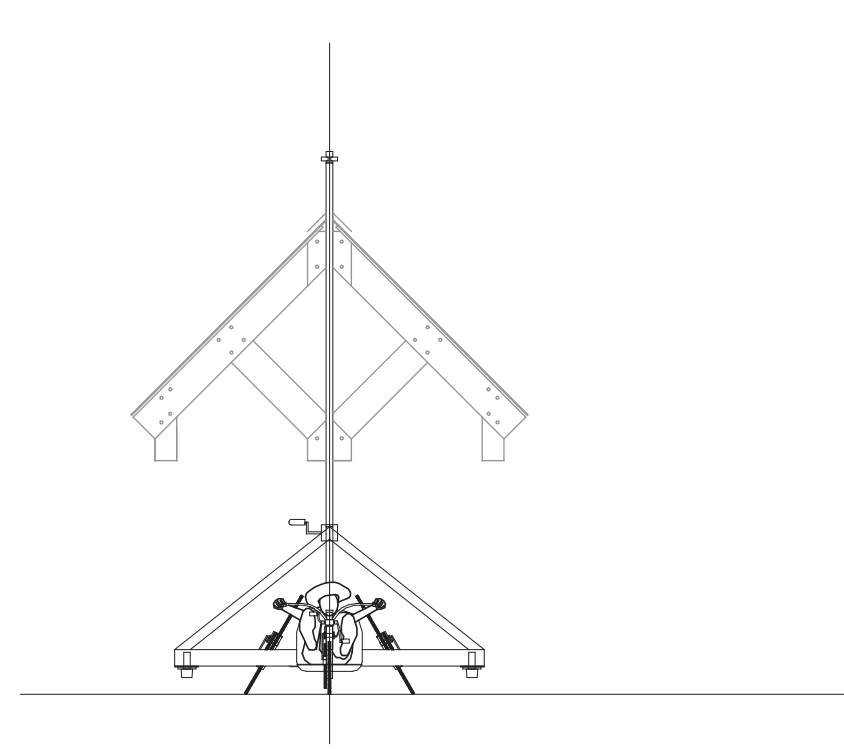
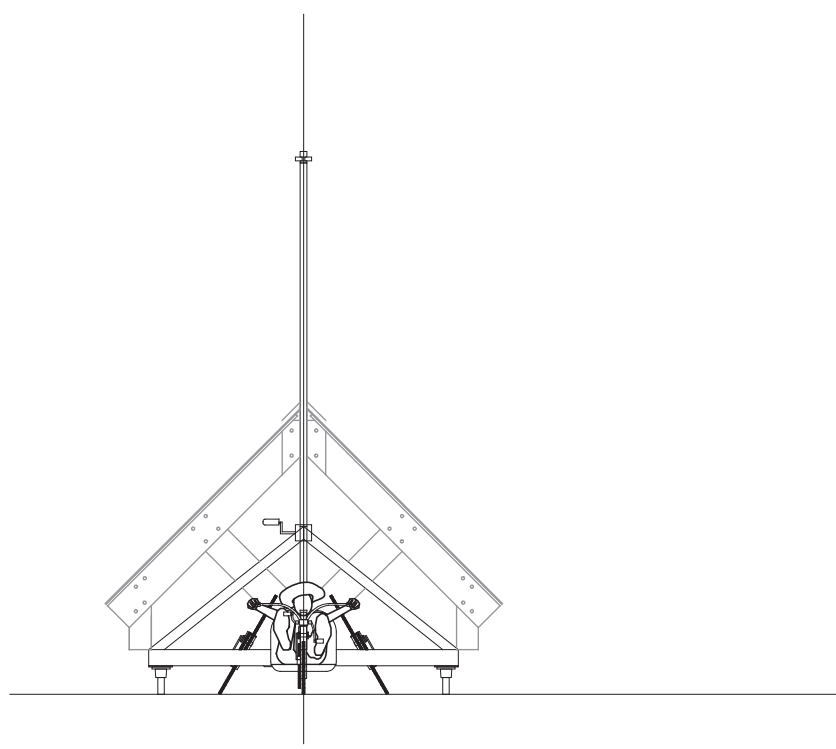
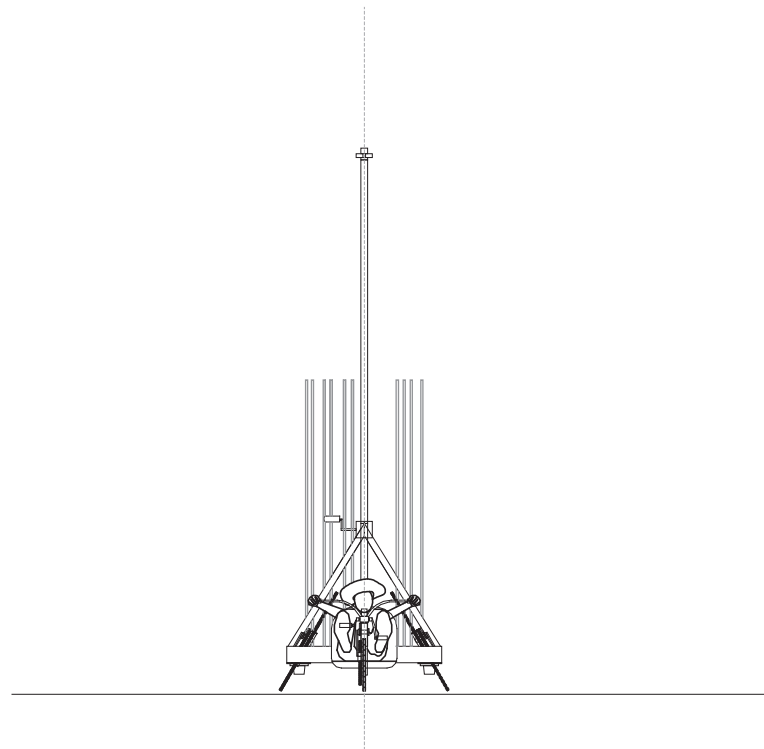
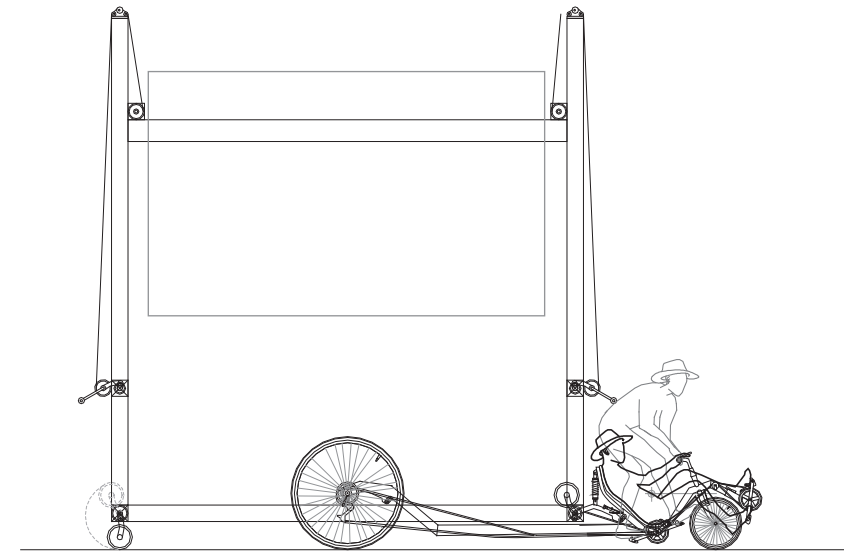
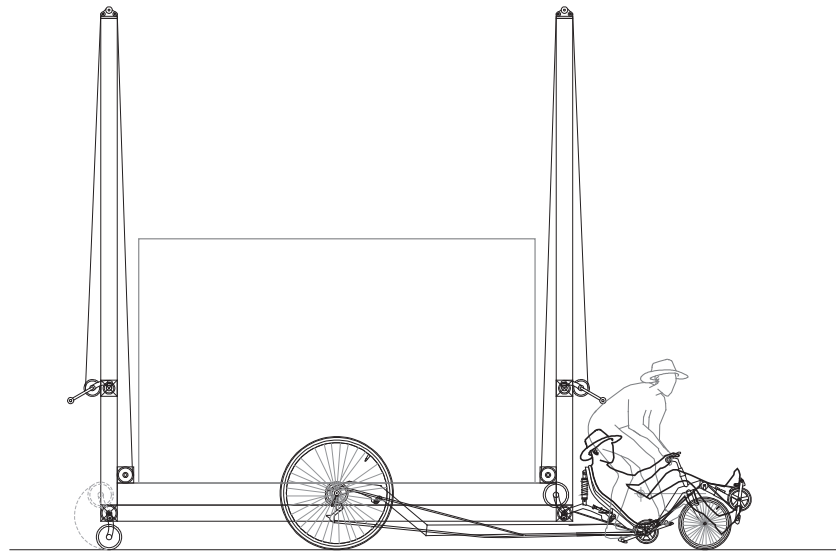
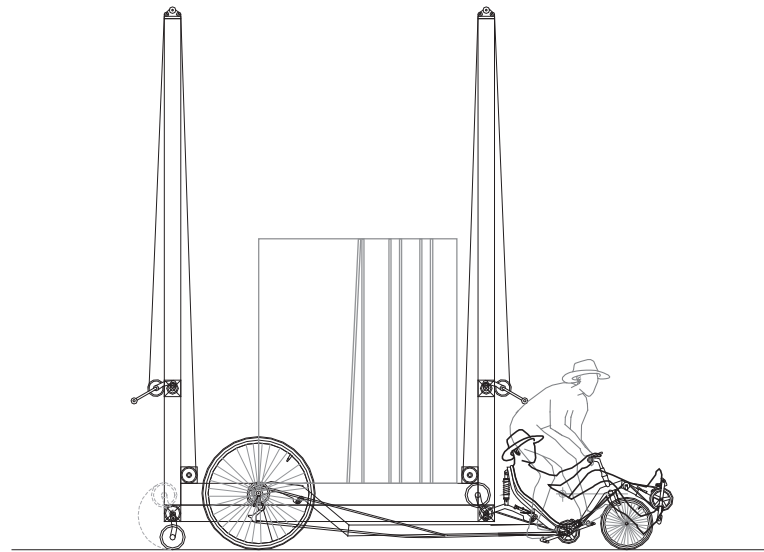

ecoplay

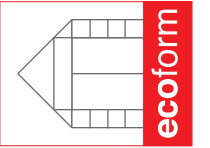

ecoform

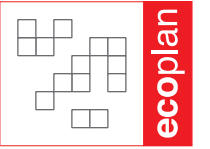

ecoplan



Island Nation Initiative

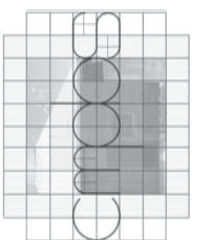

CUB

EVOLUTION OF THE GROFORM DELIVERY SYSTEM

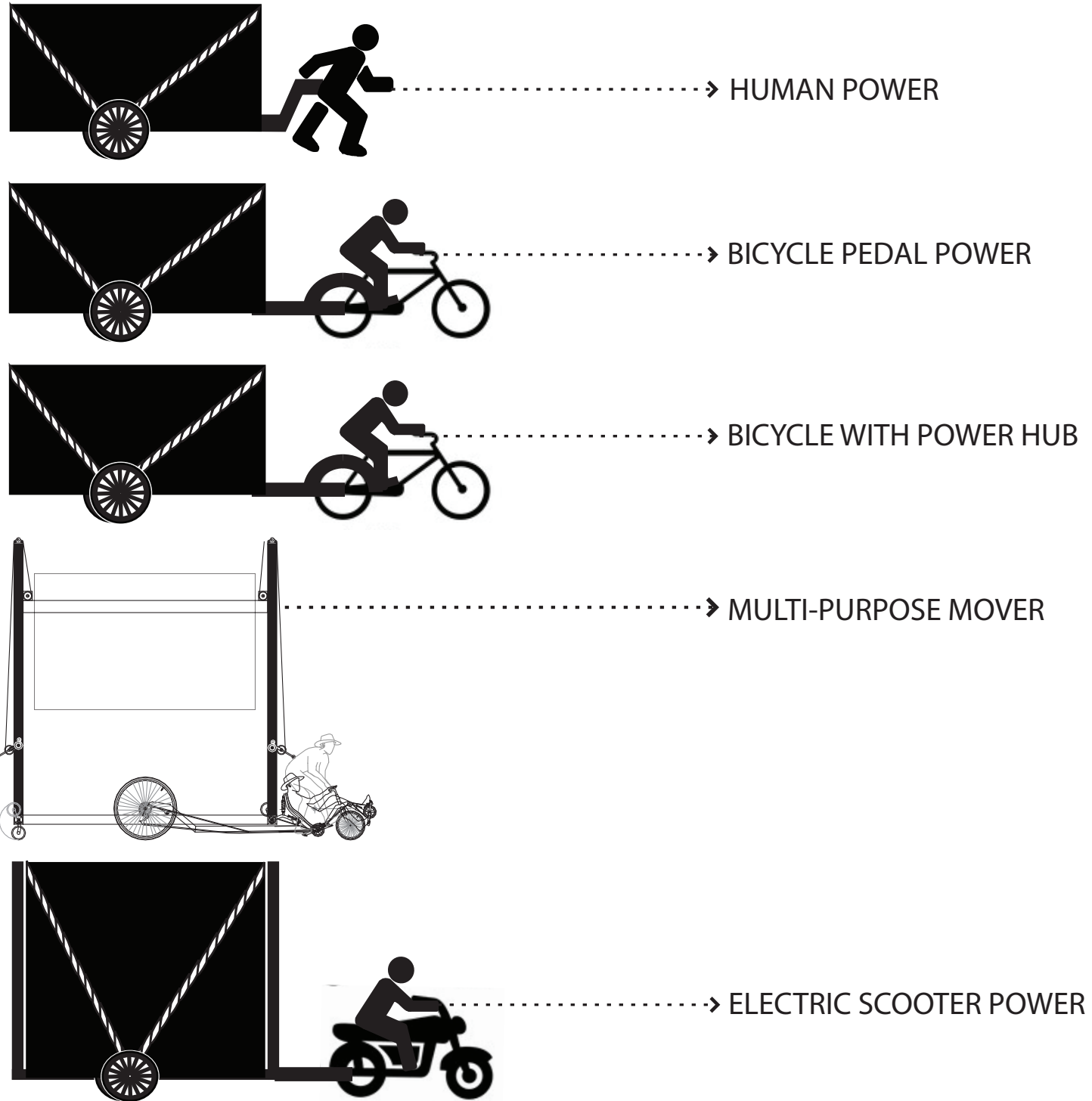

PROBLEMS IN HAITI:

- _poor roads
- _narrow lanes
- _gas/petroleum deficit
- _underused labor force
- _vehicle unfriendly terrain
- _decentralized distribution

POTENTIAL IN HAITI:

- _bikes use narrow lanes
- _bikes trucks can be built from two bikes
- _slopes + topography for power regeneration
- _need for a green transportation system in Haiti

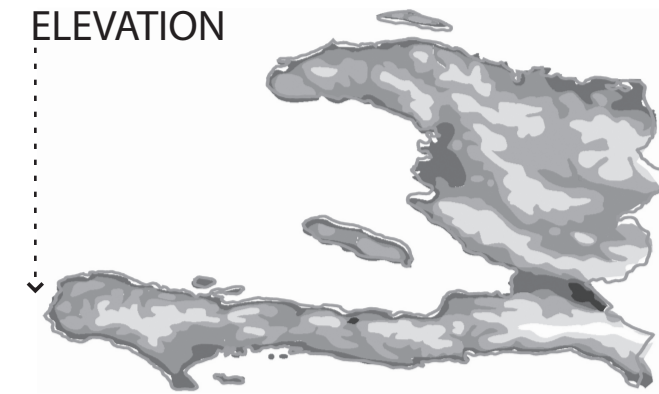

WATERSHEDS

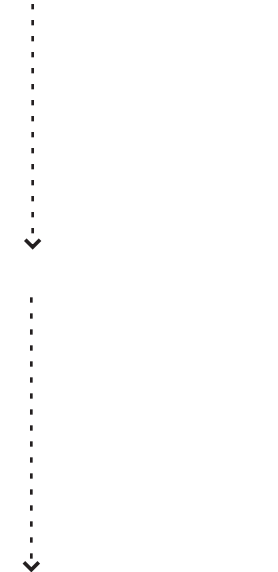

MINIMUM ENERGY/MINIMUM ENVIRONMENTAL IMPACT

